

# CAM SWITCHES



**Springer Controls** is partnered with **MERZ-PCE**, a world leader in the manufacturing of switch gears. We offer complete line of Cam Switches with as many as 24 switch contacts. Each contact has two fixed terminals and a moving contact bridge. All switches are designed with four switching angles, finger proof construction, captive screws and cable end stops, along with quality construction and excellent engineered design that surpasses the industry standards. UL, CSA, and VDE 0660 part 107 approvals as well as meeting IEC 947-3, EN60947-3 and CE all verify the excellence of the product. All MERZ products meet ROHS certification as well.

## CAM SWITCHES

Model Ratings / Product Numbering System.....	J2
Technical Data.....	J3

### CAM SWITCH TYPES:

On-Off Switches.....	J4, J5
Change-Over Switches (Transfer Switches).....	J6 - J10
Reversing Switches (Drum Switches).....	J11
Multi-Speed Switches.....	J12, J13
Wye-Delta Switches.....	J14
Step Switches (Tap Switches) with "0" Position.....	J15-J21
Step Switches (Tap Switches) with-out "0" Position.....	J22-J28
Group Switches.....	J29-J31
Code Switches.....	J32, J33
Voltmeter Switches.....	J34, J35
Ammeter Switches.....	J36-J37
Single-Phase Starter Switches.....	J38
Handle and Mounting Code.....	J39
Handle and Mounting Dimensions.....	J40
Cam Switch Enclosures.....	J41
Cam Switch Accessories.....	J42
Custom Cam Switch Order Form.....	J43

MODEL AN PRODUCT INFORMATION

Cam Switch Model Ratings

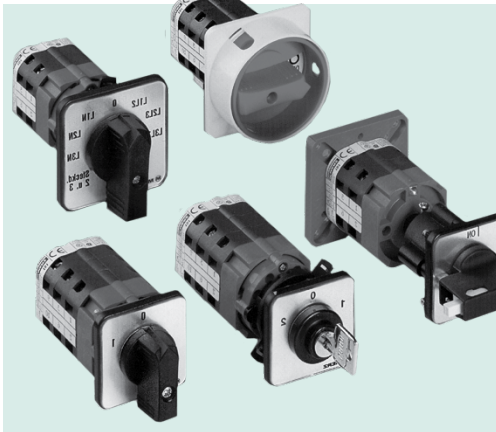

Switch Model			105	151	251	451	656	756
General Purpose 3-phase	A		16	20	25	40	80	100
	V		600	600	600	600	600	600
Motor 3-phase	240V hp		3	5	7.5	10	25	30
	480V hp		5	10	15	20	50	60
	600V hp		5	10	20	30	50	60
Motor 1-phase	120V hp		.5	1	1.5	2	7.5	10
	240V hp		1.5	2.0	3	5.0	15	20

Product Numbering System

J2

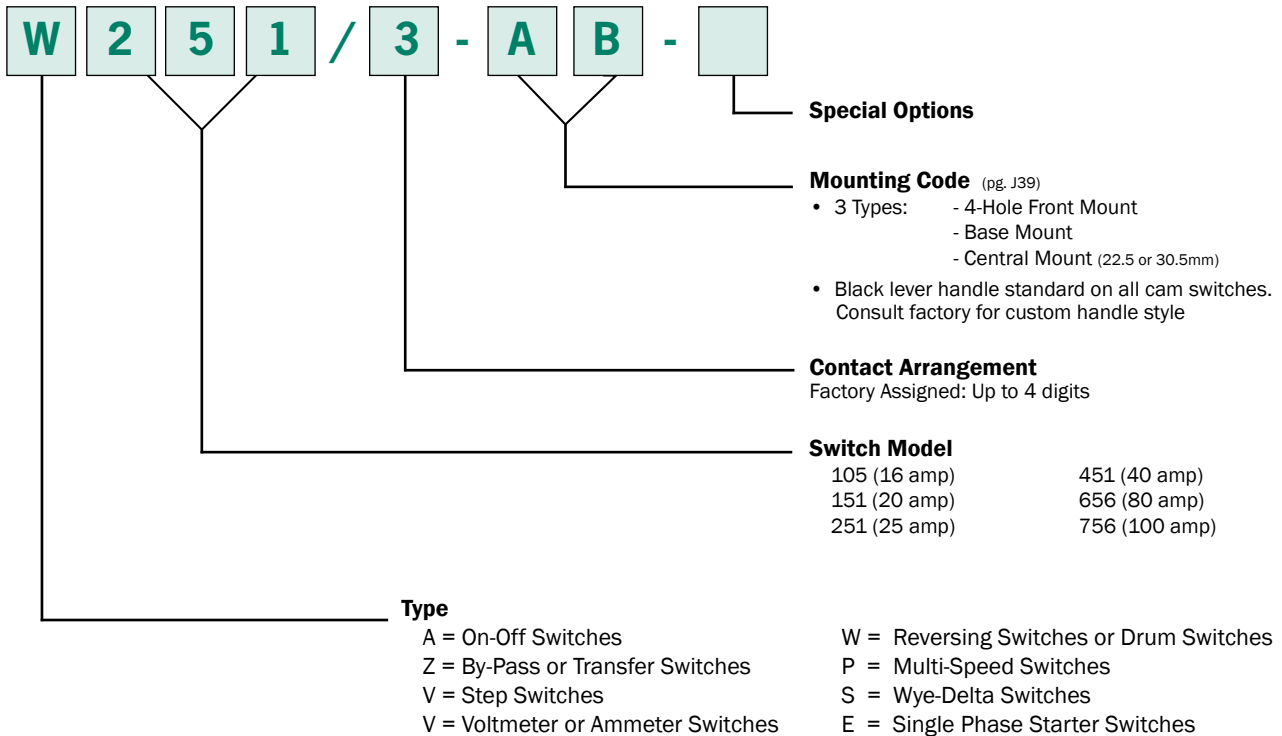

**Example:** Reversing Switch; 25amp, 3-pole maintained, 4-hole, front mount handle = Part# W251/3-AB

**Technical Data** acc. to IEC 947-3, EN 60947-3 (DIN VDE 0660 part 107), UL and CSA

Series Type			105	151	251	451	656*	756*
<b>Rated Uninterrupted current (by max. cross section)</b>								
$I_U$ open - $1_{th}$	A		20	32	40	63	80*	125*
$I_{the}$ encapsulated	A		16	25	40	63	80*	125*
Rated insulation voltage $U_i$ (III/3)	V		690	690	690	690	690	690
Rated impulse with stand. voltage $U_{imp}$ (III/3)	kV		6	6	6	6	6	6
Rated operational current $I_e$ AC-21 A	A		16	25	32	50	80*	125*
Rated operational voltage $U_e$	A		690	690	690	690	690	690
<b>Making / Breaking capacity Utilization category AC-3</b>								
	3 x 230V	kW	3	5,5	7,5	11	22	22
Motor switches	<b>3 x 400V</b>	<b>kW</b>	<b>5,5</b>	<b>7,5</b>	<b>11</b>	<b>18,5</b>	<b>37</b>	<b>45</b>
for operational switching	3 x 690V	kW	5,5	11	15	22	45	45
<b>Single phase motor</b>	1 x 230V	kW	2,2	3	4	5,5	11	11
	<b>1 x 400V</b>	<b>kW</b>	<b>3</b>	<b>4</b>	<b>5,5</b>	<b>7,5</b>	<b>15</b>	<b>18,5</b>
<b>Utilization category AC-23 A</b>								
Motor switches (Main Switches	3 x 230V	kW	4	7,5	11	15	22	37
Maintenance Switches)	<b>3 x 400V</b>	<b>kW</b>	<b>7,5</b>	<b>11</b>	<b>15</b>	<b>22</b>	<b>37</b>	<b>45</b>
	3 x 690V	kW	7,5	15	18,5	30	45	45
<b>Rated breaking capacity</b>	3 x 230V	A	150	255	370	520	750	930
<b>AC-23 A</b>	<b>3 x 400V</b>	<b>A</b>	<b>150</b>	<b>230</b>	<b>300</b>	<b>430</b>	<b>700</b>	<b>850</b>
	3 x 690V	A	90	170	210	330	490	490
<b>Utilization category AC-15</b>								
Control Switches	230V	A	6	10	12	16	20	20
Rated operational current $L_e$	400V	A	4	6	10	12	16	16
<b>Short-circuit capacity</b>								
Max. fuse rating (gl-Char.)		A	25	35	50	63	125	160
Rated conditional short-circuit current		$kA_{eff}$	4	6	6	6	-	-
Rated short-circuit making capacity $I_{cm}$		kA	-	-	-	-	3,4	3,4
Rated short-time withstand $I_{cw}$ (1-s-current)		$A_{eff}$	240	30	400	60	1200	1550
Isolating characteristics up to		V	500	500	690	690	690	690
Mechanical life – Operating cycles			$10^6$	$10^6$	$10^6$	$10^6$	$10^6$	$10^6$
Terminal screws (Pozidrive)			M3	M3,5	M4	M5	M8	2 x M4
Screwdriver: Pozidrive		Size	1	2	2	2	2	2
Torque terminal screws		Nm	0,8	1,0	1,8	2,2	3,5	3,5
Cable cross section		min. mm <sup>2</sup>	1,0	1,0	1,0	1,5	1,5	1,5
Solid or multi-stranded		min. mm <sup>2</sup>	4,0	4,0	6,0	10,0	25,0	35,0
Flexible with ferrule		min. mm <sup>2</sup>	1,0	1,0	1,0	1,5	1,5	1,5
(DIN 46228)		max. mm <sup>2</sup>	2,5	2,5	4,0	6,0	16,0	35,0

\*656 = 100 A, 756 = 160 A with usage of extension terminals. (non-UL rating)

**UL Ratings:**

	General Purpose 3-Phase	A	16	20	25	40	80	100	
		V	600	600	600	600	600	600	
	Motor 3-Phase	240V	hp	3	5	7,5	10	25	30
		480V	hp	5	10	15	20	50	60
	Motor 1-Phase (2 pole)	600V	hp	5	10	20	30	50	60
		120V	hp	0,5	1,0	1,5	2,0	7,5	10,0
		240V	hp	1,5	3,0	3,0	5,0	15,0	20,0
	Cable cross section	AWG-No		16-10	16-10	14-8	14-6	14-4	14-1

TYPE: ON-OFF SWITCHES

ON-OFF SWITCHES

Contact Arrangements	AMPS AC3	Model Number	Handle Code (see pg. J39)	Price	Front Plate / Contact Diagram
<b>1 Pole</b>	16	A105/1 -	XX	\$38.00	
	20	A151/1 -	XX	\$45.00	
	25	A251/1 -	XX	\$61.00	
	40	A451/1 -	XX	\$81.00	
	80	A656/1 -	XX	\$119.00	
	100	A756/1 -	XX	\$168.00	
<b>2 Pole</b>	16	A105/2 -	XX	\$46.00	
	20	A151/2 -	XX	\$55.00	
	25	A251/2 -	XX	\$79.00	
	40	A451/2 -	XX	\$110.00	
	80	A656/2 -	XX	\$161.00	
	100	A756/2 -	XX	\$220.00	
<b>3 Pole</b>	16	A105/3 -	XX	\$54.00	
	20	A151/3 -	XX	\$72.00	
	25	A251/3 -	XX	\$104.00	
	40	A451/3 -	XX	\$149.00	
	80	A656/3 -	XX	\$224.00	
	100	A756/3 -	XX	\$277.00	
<b>4 Pole</b>	16	A105/4 -	XX	\$62.00	
	20	A151/4 -	XX	\$80.00	
	25	A251/4 -	XX	\$117.00	
	40	A451/4 -	XX	\$172.00	
	80	A656/4 -	XX	\$266.00	
	100	A756/4 -	XX	\$334.00	
<b>1 Pole</b>	16	A105/62 -	XX	\$38.00	
	20	A151/62 -	XX	\$45.00	
	25	A251/62 -	XX	\$61.00	
	40	A451/62 -	XX	\$81.00	
	80	A656/62 -	XX	\$119.00	
	100	A756/62 -	XX	\$168.00	

XX - Replace with Handle Suffix from page J39.

Discount Schedule SC-10

**TYPE: ON-OFF SWITCHES**

**ON-OFF SWITCHES**

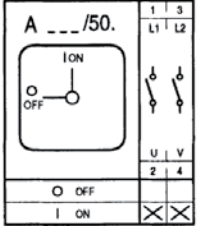
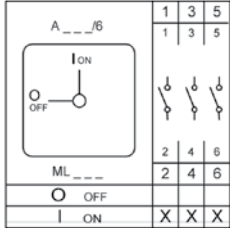
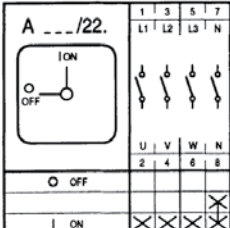
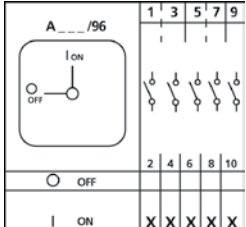
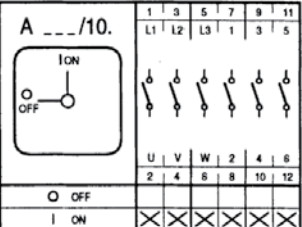
Contact Arrangements	AMPS AC3	Model Number	Handle Code (see pg. J39)	Price	Front Plate / Contact Diagram
<b>2 Pole</b>	16	A105/50 -	XX	\$46.00	
	20	A151/50 -	XX	\$55.00	
	25	A251/50 -	XX	\$79.00	
	40	A451/50 -	XX	\$110.00	
	80	A656/50 -	XX	\$161.00	
	100	A756/50 -	XX	\$220.00	
<b>3 Pole</b>	16	A105/6 -	XX	\$54.00	
	20	A151/6 -	XX	\$72.00	
	25	A251/6 -	XX	\$104.00	
	40	A451/6 -	XX	\$149.00	
	80	A656/6 -	XX	\$224.00	
	100	A756/6 -	XX	\$277.00	
<b>4 Pole 1-contact priority</b>	16	A105/22 -	XX	\$62.00	
	20	A151/22 -	XX	\$80.00	
	25	A251/22 -	XX	\$117.00	
	40	A451/22 -	XX	\$172.00	
	80	A656/22 -	XX	\$266.00	
	100	A756/22 -	XX	\$334.00	
<b>5 Pole</b>	16	A105/96 -	XX	\$75.00	
	20	A151/96 -	XX	\$98.00	
	25	A251/96 -	XX	\$142.00	
	40	A451/96 -	XX	\$209.00	
	80	A656/96 -	XX	\$330.00	
	100	A756/96 -	XX	\$405.00	
<b>6 Pole</b>	16	A105/10 -	XX	\$86.00	
	20	A151/10 -	XX	\$106.00	
	25	A251/10 -	XX	\$151.00	
	40	A451/10 -	XX	\$224.00	
	80	A656/10 -	XX	\$363.00	
	100	A756/10 -	XX	\$448.00	

**J5**

XX - Replace with Handle Suffix from page J39.

**Discount Schedule SC-10**

TYPE: CHANGE-OVER SWITCHES WITH O-POSITION

CHANGE-OVER SWITCHES WITH O-POSITION

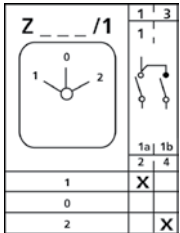
Contact Arrangements	AMPS AC3	Model Number	Handle Code (see pg. J39)	Price	Front Plate / Contact Diagram
<b>1 Pole Maintained</b>	16	Z105/1 -	XX	\$43.00	
	20	Z151/1 -	XX	\$55.00	
	25	Z251/1 -	XX	\$79.00	
	40	Z451/1 -	XX	\$110.00	
	80	Z656/1 -	XX	\$161.00	
	100	Z756/1 -	XX	\$220.00	

<b>2 Pole Maintained</b>	16	Z105/2 -	XX	\$53.00
	20	Z151/2 -	XX	\$80.00
	25	Z251/2 -	XX	\$117.00
	40	Z451/2 -	XX	\$172.00
	80	Z656/2 -	XX	\$266.00
	100	Z756/2 -	XX	\$334.00

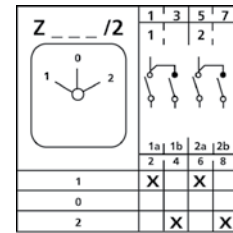

<b>3 Pole Maintained</b>	16	Z105/3 -	XX	\$74.00
	20	Z151/3 -	XX	\$106.00
	25	Z251/3 -	XX	\$151.00
	40	Z451/3 -	XX	\$224.00
	80	Z656/3 -	XX	\$363.00
	100	Z756/3 -	XX	\$448.00

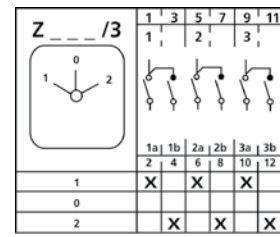

<b>4 Pole Maintained</b>	16	Z105/12 -	XX	\$83.00
	20	Z151/12 -	XX	\$132.00
	25	Z251/12 -	XX	\$184.00
	40	Z451/12 -	XX	\$272.00
	80	Z656/12 -	XX	\$448.00
	100	Z756/12 -	XX	\$563.00

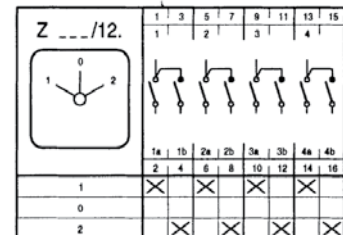

XX - Replace with Handle Suffix from page J39.

Discount Schedule SC-10

**TYPE: CHANGE-OVER SWITCHES WITH O-POSITION**

**CHANGE-OVER SWITCHES WITH O-POSITION**

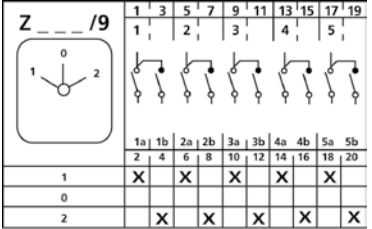
Contact Arrangements	AMPS AC3	Model Number	Handle Code (see pg. J39)	Price	Font Plate / Contact Diagram
<b>5 Pole Maintained</b>	16	Z105/9 -	XX	\$108.00	
	20	Z151/9 -	XX	\$160.00	
	25	Z251/9 -	XX	\$219.00	
	40	Z451/9 -	XX	\$318.00	
	80	Z656/9 -	XX	\$534.00	
	100	Z756/9 -	XX	\$673.00	

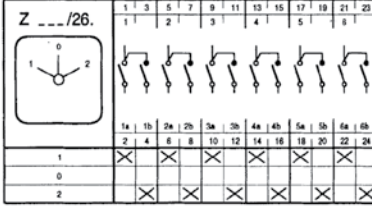
<b>6 Pole Maintained</b>	16	Z105/26 -	XX	\$125.00	
	20	Z151/26 -	XX	\$186.00	
	25	Z251/26 -	XX	\$252.00	
	40	Z451/26 -	XX	\$368.00	
	80	Z656/26 -	XX	\$620.00	
	100	Z756/26 -	XX	\$790.00	

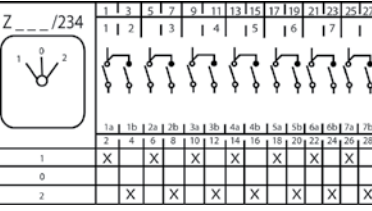
<b>7 Pole Maintained</b>	16	Z105/234 -	XX	\$135.00	
	20	Z151/234 -	XX	\$212.00	
	25	Z251/234 -	XX	\$286.00	
	40	Z451/234 -	XX	\$415.00	
	80	Z656/234 -	XX	\$707.00	
	100	Z756/234 -	XX	\$908.00	

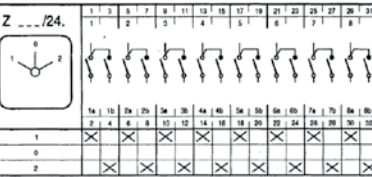
<b>8 Pole Maintained</b>	16	Z105/24 -	XX	\$145.00	
	20	Z151/24 -	XX	\$238.00	
	25	Z251/24 -	XX	\$320.00	
	40	Z451/24 -	XX	\$466.00	
	80	Z656/24 -	XX	\$794.00	
	100	Z756/24 -	XX	\$1025.00	

XX - Replace with Handle Suffix from page J39.

**Discount Schedule SC-10**

TYPE: CHANGE-OVER SWITCHES WITH NO O-POSITION

CHANGE-OVER SWITCHES WITH NO O-POSITION

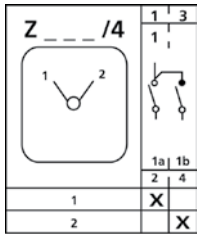
Contact Arrangements	AMPS AC3	Model Number	Handle Code (see pg. J39)	Price	Front Plate / Contact Diagram
<b>1 Pole Maintained</b>	16	Z105/4 -	XX	\$43.00	
	20	Z151/4 -	XX	\$55.00	
	25	Z251/4 -	XX	\$79.00	
	40	Z451/4 -	XX	\$110.00	
	80	Z656/4 -	XX	\$161.00	
	100	Z756/4 -	XX	\$220.00	

<b>2 Pole Maintained</b>	16	Z105/5 -	XX	\$53.00
	20	Z151/5 -	XX	\$80.00
	25	Z251/5 -	XX	\$117.00
	40	Z451/5 -	XX	\$172.00
	80	Z656/5 -	XX	\$266.00
	100	Z756/5 -	XX	\$334.00

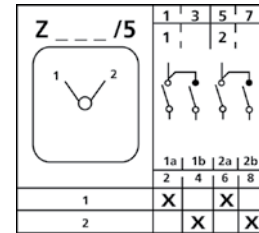

<b>3 Pole Maintained</b>	16	Z105/6 -	XX	\$74.00
	20	Z151/6 -	XX	\$106.00
	25	Z251/6 -	XX	\$151.00
	40	Z451/6 -	XX	\$224.00
	80	Z656/6 -	XX	\$363.00
	100	Z756/6 -	XX	\$448.00

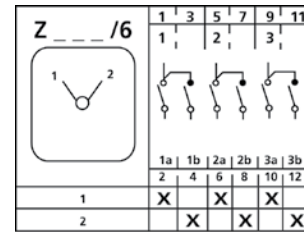

<b>4 Pole Maintained</b>	16	Z105/23 -	XX	\$83.00
	20	Z151/23 -	XX	\$132.00
	25	Z251/23 -	XX	\$184.00
	40	Z451/23 -	XX	\$292.00
	80	Z656/23 -	XX	\$448.00
	100	Z756/23 -	XX	\$563.00

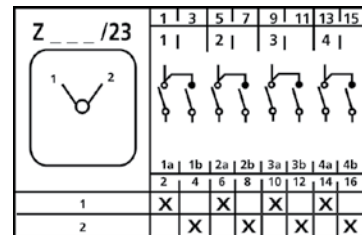

XX - Replace with Handle Suffix from page J39.

Discount Schedule SC-10



**TYPE: CHANGE-OVER SWITCHES WITH NO O-POSITION**

**CHANGE-OVER SWITCHES WITH NO O-POSITION**

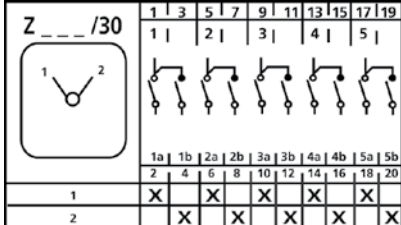
Contact Arrangements	AMPS AC3	Model Number	Handle Code (see pg. J39)	Price	Front Plate / Contact Diagram
<b>5 Pole Maintained</b>	16	Z105/30 -	XX	\$108.00	
	20	Z151/30 -	XX	\$159.00	
	25	Z251/30 -	XX	\$219.00	
	40	Z451/30 -	XX	\$238.00	
	80	Z656/30 -	XX	\$534.00	
	100	Z756/30 -	XX	\$673.00	

<b>6 Pole Maintained</b>	16	Z105/46 -	XX	\$125.00
	20	Z151/46 -	XX	\$186.00
	25	Z251/46 -	XX	\$252.00
	40	Z451/46 -	XX	\$368.00
	80	Z656/46 -	XX	\$620.00
	100	Z756/46 -	XX	\$790.00

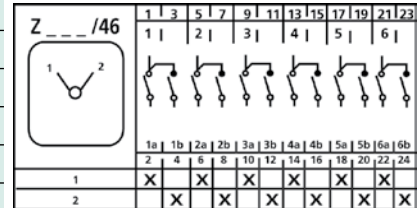

<b>7 Pole Maintained</b>	16	Z105/27 -	XX	\$135.00
	20	Z151/27 -	XX	\$212.00
	25	Z251/27 -	XX	\$286.00
	40	Z451/27 -	XX	\$417.00
	80	Z656/27 -	XX	\$707.00
	100	Z756/27 -	XX	\$908.00

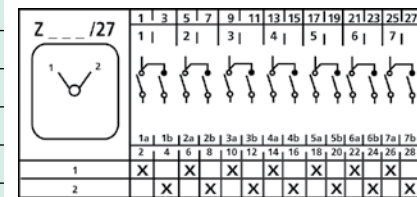

<b>8 Pole Maintained</b>	16	Z105/15 -	XX	\$145.00
	20	Z151/15 -	XX	\$238.00
	25	Z251/15 -	XX	\$320.00
	40	Z451/15 -	XX	\$466.00
	80	Z656/15 -	XX	\$794.00
	100	Z756/15 -	XX	\$1025.00

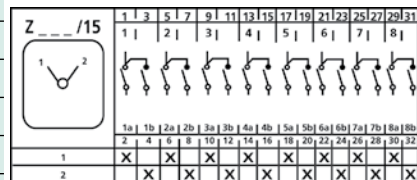

XX - Replace with Handle Suffix from page J39.

**Discount Schedule SC-10**

**J9**

TYPE: CHANGE-OVER SWITCHES WITH NO O-POSITION

CHANGE-OVER SWITCHES WITH NO O-POSITION

Contact Arrangements	AMPS AC3	Model Number	Handle Code (see pg. J39)	Price	Front Plate / Contact Diagram
----------------------	----------	--------------	---------------------------	-------	-------------------------------

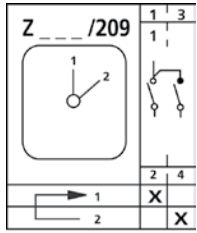
<b>1 Pole Spring Return</b>	16	Z105/209 -	XX	\$43.00	
	20	Z151/209 -	XX	\$56.00	
	25	Z251/209 -	XX	\$79.00	
	40	Z451/209 -	XX	\$110.00	
	80	Z656/209 -	XX	\$161.00	
	100	Z756/209 -	XX	\$220.00	

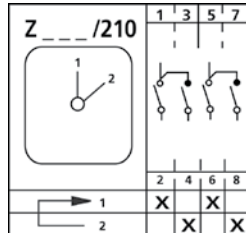
<b>2 Pole Spring Return</b>	16	Z105/210 -	XX	\$53.00	
	20	Z151/210 -	XX	\$81.00	
	25	Z251/210 -	XX	\$117.00	
	40	Z451/210 -	XX	\$172.00	
	80	Z656/210 -	XX	\$266.00	
	100	Z756/210 -	XX	\$334.00	

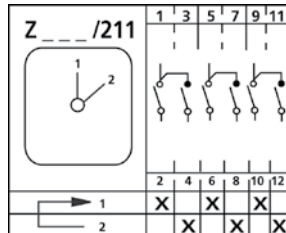
<b>3 Pole Spring Return</b>	16	Z105/211 -	XX	\$74.00	
	20	Z151/211 -	XX	\$107.00	
	25	Z251/211 -	XX	\$151.00	
	40	Z451/211 -	XX	\$224.00	
	80	Z656/211 -	XX	\$361.00	
	100	Z756/211 -	XX	\$448.00	

XX - Replace with Handle Suffix from page J39.

Discount Schedule SC-10

J10

**TYPE: REVERSING SWITCHES**

**REVERSING SWITCHES**

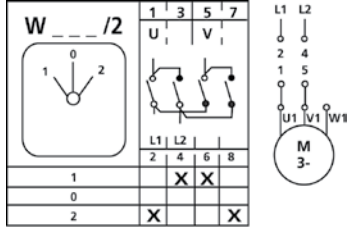
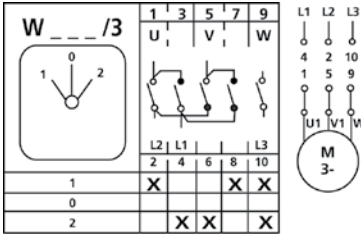
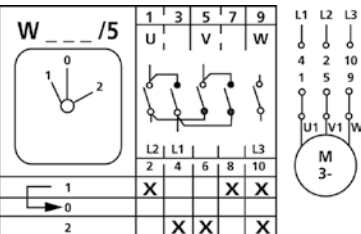
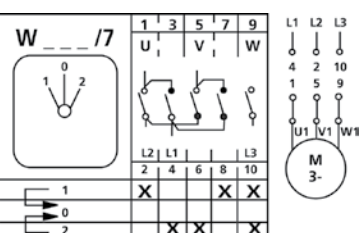
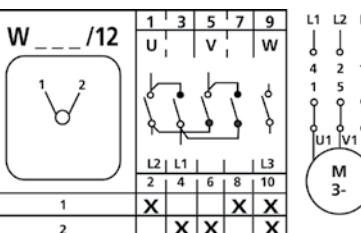
Contact Arrangements	AMPS AC3	Model Number	Handle Code (see pg. J39)	Price	Front Plate / Contact Diagram
<b>2 Pole Maintained</b>	16	W105/2 -	XX	\$53.00	
	20	W151/2 -	XX	\$80.00	
	25	W251/2 -	XX	\$117.00	
	40	W451/2 -	XX	\$172.00	
	80	W656/2 -	XX	\$266.00	
	100	W756/2 -	XX	\$334.00	
<b>3 Pole Maintained</b>	16	W105/3 -	XX	\$63.00	
	20	W151/3 -	XX	\$98.00	
	25	W251/3 -	XX	\$142.00	
	40	W451/3 -	XX	\$209.00	
	80	W656/3 -	XX	\$329.00	
	100	W756/3 -	XX	\$405.00	
<b>3 Pole with spring return from 1 - 0</b>	16	W105/5 -	XX	\$63.00	
	20	W151/5 -	XX	\$98.00	
	25	W251/5 -	XX	\$142.00	
	40	W451/5 -	XX	\$209.00	
	80	W656/5 -	XX	\$329.00	
	100	W756/5 -	XX	\$405.00	
<b>3 Pole with spring return both sides</b>	16	W105/7 -	XX	\$63.00	
	20	W151/7 -	XX	\$98.00	
	25	W251/7 -	XX	\$142.00	
	40	W451/7 -	XX	\$209.00	
	80	W656/7 -	XX	\$329.00	
	100	W756/7 -	XX	\$405.00	
<b>3 Pole without 0-Position Maintained</b>	16	W105/12 -	XX	\$63.00	
	20	W151/12 -	XX	\$98.00	
	25	W251/12 -	XX	\$142.00	
	40	W451/12 -	XX	\$209.00	
	80	W656/12 -	XX	\$329.00	
	100	W756/12 -	XX	\$405.00	

**J11**

XX - Replace with Handle Suffix from page J39.

**Discount Schedule SC-10**

**TYPE: MULTI-SPEED SWITCHES**

Contact Arrangements	AMPS AC3	Model Number	Handle Code (see pg. J39)	Price	Front Plate / Contact Diagram
<b>2-Speed Switches Tapped Windings</b>	16	P105/1 -	XX	\$83.00	
	20	P151/1 -	XX	\$132.00	
	25	P251/1 -	XX	\$184.00	
	40	P451/1 -	XX	\$272.00	
	80	P656/1 -	XX	\$448.00	
	100	P756/1 -	XX	\$563.00	
<b>2-Speed Switches Tapped Windings with 1 Contact</b>	16	P105/2 -	XX	\$107.00	
	20	P151/2 -	XX	\$159.00	
	25	P251/2 -	XX	\$218.00	
	40	P451/2 -	XX	\$320.00	
	80	P656/2 -	XX	\$534.00	
	100	P756/2 -	XX	\$677.00	
<b>2-Speed Switches Tapped Windings 0 Middle</b>	16	P105/5 -	XX	\$83.00	
	20	P151/5 -	XX	\$132.00	
	25	P251/5 -	XX	\$184.00	
	40	P451/5 -	XX	\$272.00	
	80	P656/5 -	XX	\$448.00	
	100	P756/5 -	XX	\$563.00	
<b>2-Speed Switches 2 Separate Windings</b>	16	P105/7 -	XX	\$74.00	
	20	P151/7 -	XX	\$106.00	
	25	P251/7 -	XX	\$151.00	
	40	P451/7 -	XX	\$224.00	
	80	P656/7 -	XX	\$363.00	
	100	P756/7 -	XX	\$448.00	
<b>2-Speed Switches With Starting Position</b>	16	P105/6 -	XX	\$118.00	
	20	P151/6 -	XX	\$176.00	
	25	P251/6 -	XX	\$240.00	
	40	P451/6 -	XX	\$352.00	
	80	P656/6 -	XX	\$590.00	
	100	P756/6 -	XX	\$747.00	
<b>2-Speed Switches 2 Separate Windings</b>	16	P105/48 -	XX	\$74.00	
	20	P151/48 -	XX	\$106.00	
	25	P251/48 -	XX	\$151.00	
	40	P451/48 -	XX	\$224.00	
	80	P656/48 -	XX	\$363.00	
	100	P756/48 -	XX	\$448.00	

XX - Replace with Handle Suffix from page J39.

**Discount Schedule SC-10**

**TYPE: MULTI-SPEED SWITCHES**

**MULTI-SPEED SWITCHES**

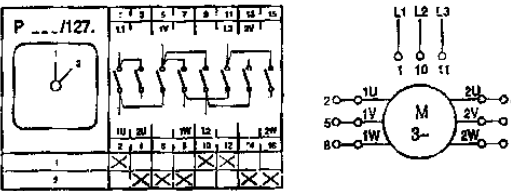
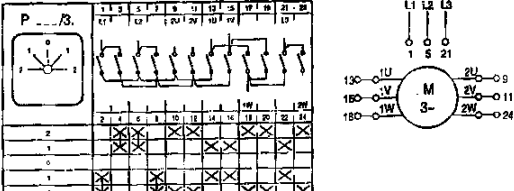
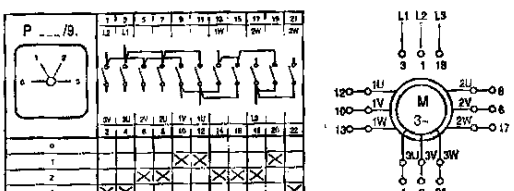
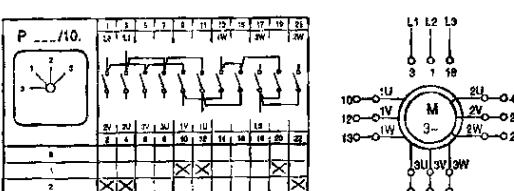
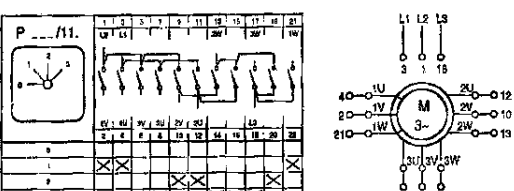
Contact Arrangements	AMPS AC3	Model Number	Handle Code (see pg. J39)	Price	Front Plate / Contact Diagram
<b>2-Speed Switches Tapped Windings Without 0 Position</b>	16	P105/127 -	XX	\$83.00	
	20	P151/127 -	XX	\$132.00	
	25	P251/127 -	XX	\$184.00	
	40	P451/127 -	XX	\$272.00	
	80	P656/127 -	XX	\$448.00	
100	P756/127 -	XX	\$563.00		
<b>2-Speed Switches Tapped Windings 2 Reversing</b>	16	P105/3 -	XX	\$127.00	
	20	P151/3 -	XX	\$186.00	
	25	P251/3 -	XX	\$251.00	
	40	P451/3 -	XX	\$368.00	
	80	P656/3 -	XX	\$620.00	
100	P756/3 -	XX	\$791.00		
<b>3-Speed Tapped Windings 1 and 2</b>	16	P105/9 -	XX	\$118.00	
	20	P151/9 -	XX	\$176.00	
	25	P251/9 -	XX	\$240.00	
	40	P451/9 -	XX	\$352.00	
	80	P656/9 -	XX	\$590.00	
100	P756/9 -	XX	\$747.00		
<b>3-Speed Switches Tapped Windings 1 and 3</b>	16	P105/10 -	XX	\$118.00	
	20	P151/10 -	XX	\$176.00	
	25	P251/10 -	XX	\$240.00	
	40	P451/10 -	XX	\$352.00	
	80	P656/10 -	XX	\$590.00	
100	P756/10 -	XX	\$747.00		
<b>3-Speed Switches Tapped Windings 2 and 3</b>	16	P105/11 -	XX	\$118.00	
	20	P151/11 -	XX	\$176.00	
	25	P251/11 -	XX	\$240.00	
	40	P451/11 -	XX	\$352.00	
	80	P656/11 -	XX	\$590.00	
100	P756/11 -	XX	\$747.00		

**J13**

XX - Replace with Handle Suffix from page J39.

**Discount Schedule SC-10**

**TYPE: WYE-DELTA SWITCHES**

Contact Arrangements	AMPS AC3	Model Number	Handle Code (see pg. J39)	Price	Front Plate / Contact Diagram
<b>Standard</b>	16	S105/1 -	XX	\$83.00	
	20	S151/1 -	XX	\$132.00	
	25	S251/1 -	XX	\$184.00	
	40	S451/1 -	XX	\$272.00	
	80	S656/1 -	XX	\$448.00	
	100	S756/1 -	XX	\$563.00	
<b>With 1 Contact without Main Contacts</b>	16	S105/2 -	XX	\$80.00	
	20	S151/2 -	XX	\$124.00	
	25	S251/2 -	XX	\$174.00	
	40	S451/2 -	XX	\$257.00	
	80	S656/2 -	XX	\$418.00	
	100	S756/2 -	XX	\$519.00	
<b>With 1 Contact</b>	16	S105/26 -	XX	\$107.00	
	20	S151/26 -	XX	\$159.00	
	25	S251/26 -	XX	\$218.00	
	40	S451/26 -	XX	\$320.00	
	80	S656/26 -	XX	\$534.00	
	100	S756/26 -	XX	\$677.00	
<b>For Individually Compensated Motors</b>	16	S105/5 -	XX	\$83.00	
	20	S151/5 -	XX	\$132.00	
	25	S251/5 -	XX	\$184.00	
	40	S451/5 -	XX	\$272.00	
	80	S656/5 -	XX	\$448.00	
	100	S756/5 -	XX	\$563.00	
<b>2 Reversing</b>	16	S105/3 -	XX	\$107.00	
	20	S151/3 -	XX	\$159.00	
	25	S251/3 -	XX	\$218.00	
	40	S451/3 -	XX	\$320.00	
	80	S656/3 -	XX	\$534.00	
	100	S756/3 -	XX	\$677.00	
<b>2 Reversing With Contact</b>	16	S105/16 -	XX	\$125.00	
	20	S151/16 -	XX	\$186.00	
	25	S251/16 -	XX	\$251.00	
	40	S451/16 -	XX	\$368.00	
	80	S656/16 -	XX	\$620.00	
	100	S756/16 -	XX	\$791.00	
<b>2 Reversing for Individually Compensated Motors</b>	16	S105/27 -	XX	\$107.00	
	20	S151/27 -	XX	\$159.00	
	25	S251/27 -	XX	\$218.00	
	40	S451/27 -	XX	\$320.00	
	80	S656/27 -	XX	\$534.00	
	100	S756/27 -	XX	\$677.00	

XX - Replace with Handle Suffix from page J39.

Discount Schedule SC-10

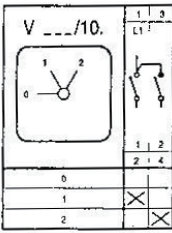
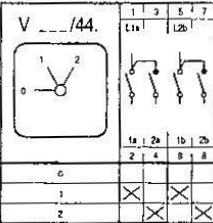
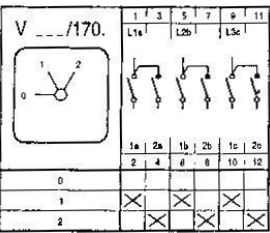
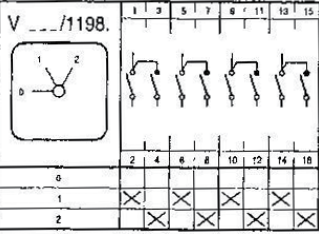
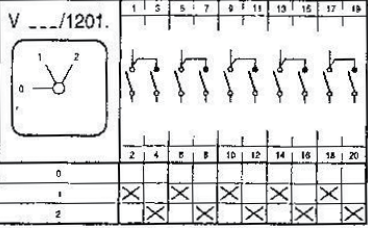
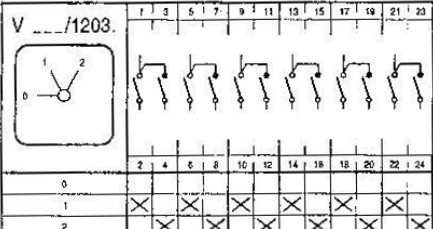

**TYPE: STEP SWITCHES WITH 0-POSITION 2 STEPS**

Contact Arrangements	AMPS AC3	Model Number	Handle Code (see pg. J39)	Price	Front Plate / Contact Diagram
<b>1 Pole</b>	16	V105/10 -	XX	\$43.00	
	20	V151/10 -	XX	\$56.00	
	25	V251/10 -	XX	\$80.00	
	40	V451/10 -	XX	\$111.00	
	80	V656/10 -	XX	\$161.00	
	100	V756/10 -	XX	\$220.00	
<b>2 Pole</b>	16	V105/44 -	XX	\$53.00	
	20	V151/44 -	XX	\$80.00	
	25	V251/44 -	XX	\$117.00	
	40	V451/44 -	XX	\$172.00	
	80	V656/44 -	XX	\$266.00	
	100	V756/44 -	XX	\$334.00	
<b>3 Pole</b>	16	V105/170 -	XX	\$74.00	
	20	V151/170 -	XX	\$106.00	
	25	V251/170 -	XX	\$151.00	
	40	V451/170 -	XX	\$224.00	
	80	V656/170 -	XX	\$363.00	
	100	V756/170 -	XX	\$448.00	
<b>4 Pole</b>	16	V105/1198 -	XX	\$84.00	
	20	V151/1198 -	XX	\$132.00	
	25	V251/1198 -	XX	\$185.00	
	40	V451/1198 -	XX	\$271.00	
	80	V656/1198 -	XX	\$448.00	
	100	V756/1198 -	XX	\$563.00	
<b>5 Pole</b>	16	V105/1201 -	XX	\$108.00	
	20	V151/1201 -	XX	\$159.00	
	25	V251/1201 -	XX	\$218.00	
	40	V451/1201 -	XX	\$317.00	
	80	V656/1201 -	XX	\$534.00	
	100	V756/1201 -	XX	\$677.00	
<b>6 Pole</b>	16	V105/1203 -	XX	\$124.00	
	20	V151/1203 -	XX	\$185.00	
	25	V251/1203 -	XX	\$252.00	
	40	V451/1203 -	XX	\$366.00	
	80	V656/1203 -	XX	\$620.00	
	100	V756/1203 -	XX	\$791.00	

XX - Replace with Handle Suffix from page J39.

**Discount Schedule SC-10**

**TYPE: STEP SWITCHES WITH 0-POSITION 3 STEPS**

**STEP SWITCHES WITH 0-POSITION 3 STEPS**

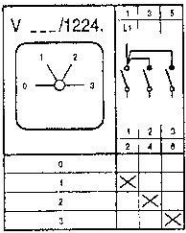
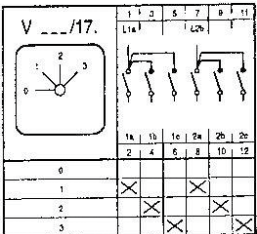
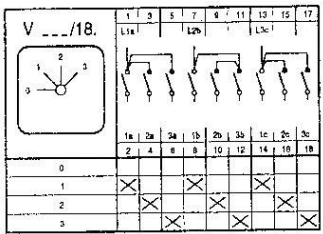
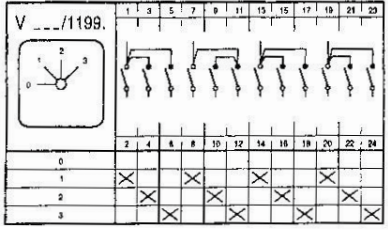
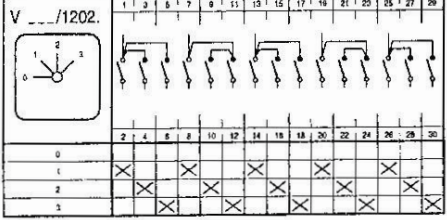
Contact Arrangements	AMPS AC3	Model Number	Handle Code (see pg. J39)	Price	Front Plate / Contact Diagram
<b>1 Pole</b>	16	V105/1224 -	XX	\$48.00	
	20	V151/1224 -	XX	\$72.00	
	25	V251/1224 -	XX	\$104.00	
	40	V451/1224 -	XX	\$149.00	
	80	V656/1224 -	XX	\$224.00	
	100	V756/1224 -	XX	\$277.00	
<b>2 Pole</b>	16	V105/17 -	XX	\$74.00	
	20	V151/17 -	XX	\$107.00	
	25	V251/17 -	XX	\$152.00	
	40	V451/17 -	XX	\$224.00	
	80	V656/17 -	XX	\$363.00	
	100	V756/17 -	XX	\$448.00	
<b>3 Pole</b>	16	V105/18 -	XX	\$102.00	
	20	V151/18 -	XX	\$150.00	
	25	V251/18 -	XX	\$208.00	
	40	V451/18 -	XX	\$305.00	
	80	V656/18 -	XX	\$502.00	
	100	V756/18 -	XX	\$633.00	
<b>4 Pole</b>	16	V105/1199 -	XX	\$124.00	
	20	V151/1199 -	XX	\$185.00	
	25	V251/1199 -	XX	\$252.00	
	40	V451/1199 -	XX	\$366.00	
	80	V656/1199 -	XX	\$620.00	
	100	V756/1199 -	XX	\$791.00	
<b>5 Pole</b>	16	V105/1202 -	XX	\$140.00	
	20	V151/1202 -	XX	\$229.00	
	25	V251/1202 -	XX	\$308.00	
	40	V451/1202 -	XX	\$449.00	
	80	V656/1202 -	XX	\$761.00	
	100	V756/1202 -	XX	\$978.00	

XX - Replace with Handle Suffix from page J39.

Discount Schedule SC-10

J16



**TYPE: STEP SWITCHES WITH 0-POSITION 4 STEPS**

**STEP SWITCHES WITH 0-POSITION 4 STEPS**

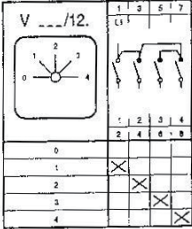
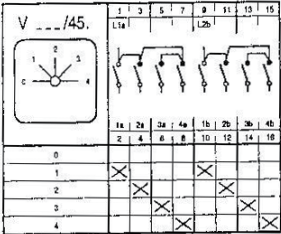
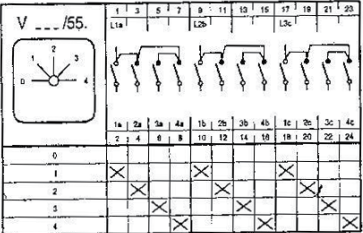
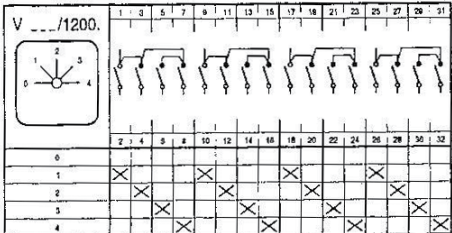
Contact Arrangements	AMPS AC3	Model Number	Handle Code (see pg. J39)	Price	Front Plate / Contact Diagram
<b>1 Pole</b>	16	V105/12 -	XX	\$53.00	
	20	V151/12 -	XX	\$81.00	
	25	V251/12 -	XX	\$117.00	
	40	V451/12 -	XX	\$172.00	
	80	V656/12 -	XX	\$266.00	
	100	V756/12 -	XX	\$334.00	
<b>2 Pole</b>	16	V105/45 -	XX	\$84.00	
	20	V151/45 -	XX	\$132.00	
	25	V251/45 -	XX	\$185.00	
	40	V451/45 -	XX	\$271.00	
	80	V656/45 -	XX	\$448.00	
	100	V756/45 -	XX	\$563.00	
<b>3 Pole</b>	16	V105/55 -	XX	\$124.00	
	20	V151/55 -	XX	\$185.00	
	25	V251/55 -	XX	\$252.00	
	40	V451/55 -	XX	\$366.00	
	80	V656/55 -	XX	\$620.00	
	100	V756/55 -	XX	\$791.00	
<b>4 Pole</b>	16	V105/1200 -	XX	\$144.00	
	20	V151/1200 -	XX	\$237.00	
	25	V251/1200 -	XX	\$318.00	
	40	V451/1200 -	XX	\$465.00	
	80	V656/1200 -	XX	\$791.00	
	100	V756/1200 -	XX	\$1021.00	

XX - Replace with Handle Suffix from page J39.

**Discount Schedule SC-10**

**J17**

TYPE: STEP SWITCHES WITH 0-POSITION 5 STEPS

STEP SWITCHES WITH 0-POSITION 5 STEPS

Contact Arrangements	AMPS AC3	Model Number	Handle Code (see pg. J39)	Price	Front Plate / Contact Diagram
----------------------	----------	--------------	---------------------------	-------	-------------------------------

<b>1 Pole</b>	16	V105/1225 -	XX	\$70.00
	20	V151/1225 -	XX	\$98.00
	25	V251/1225 -	XX	\$141.00
	40	V451/1225 -	XX	\$208.00
	80	V656/1225 -	XX	\$329.00
	100	V756/1225 -	XX	\$403.00

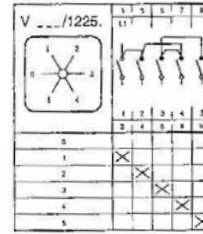

<b>2 Pole</b>	16	V105/171 -	XX	\$108.00
	20	V151/171 -	XX	\$159.00
	25	V251/171 -	XX	\$218.00
	40	V451/171 -	XX	\$317.00
	80	V656/171 -	XX	\$620.00
	100	V756/171 -	XX	\$677.00

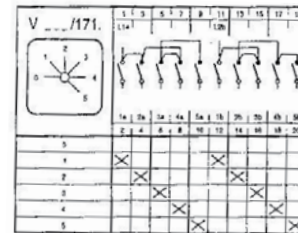

<b>3 Pole</b>	16	V105/1195 -	XX	\$140.00
	20	V151/1195 -	XX	\$229.00
	25	V251/1195 -	XX	\$308.00
	40	V451/1195 -	XX	\$449.00
	80	V656/1195 -	XX	\$761.00
	100	V756/1195 -	XX	\$978.00

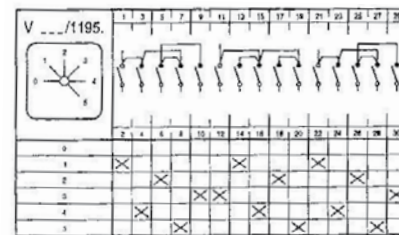

J18

XX - Replace with Handle Suffix from page J39.

Discount Schedule SC-10

**TYPE: STEP SWITCHES WITH 0-POSITION 6 STEPS**

**STEP SWITCHES WITH 0-POSITION 6 STEPS**

Contact Arrangements	AMPS AC3	Model Number	Handle Code (see pg. J39)	Price	Front Plate / Contact Diagram
<b>1 Pole</b>	16	V105/60 -	XX	\$74.00	
	20	V151/60 -	XX	\$106.00	
	25	V251/60 -	XX	\$151.00	
	40	V451/60 -	XX	\$224.00	
	80	V656/60 -	XX	\$363.00	
	100	V756/60 -	XX	\$448.00	

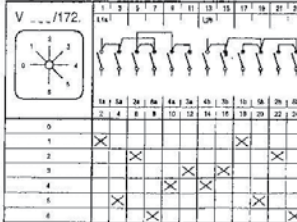
<b>2 Pole</b>	16	V105/172 -	XX	\$125.00	
	20	V151/172 -	XX	\$186.00	
	25	V251/172 -	XX	\$251.00	
	40	V451/172 -	XX	\$368.00	
	80	V656/172 -	XX	\$620.00	
	100	V756/172 -	XX	\$791.00	

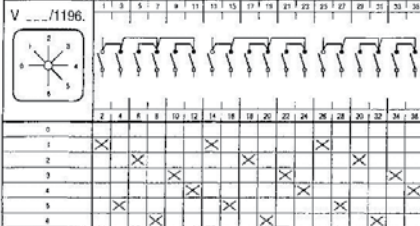
<b>3 Pole</b>	16	V105/1196 -	XX	\$155.00	
	20	V151/1196 -	XX	\$264.00	
	25	V251/1196 -	XX	\$352.00	
	40	V451/1196 -	XX	\$513.00	
	80	V656/1196 -	XX	\$877.00	
	100	V756/1196 -	XX	\$1138.00	

**J19**

XX - Replace with Handle Suffix from page J39.

**Discount Schedule SC-10**

**TYPE: STEP SWITCHES WITH 0-POSITION 7/8/9 STEPS**

**STEP SWITCHES WITH 0-POSITION 7/8/9 STEPS**

Contact Arrangements	AMPS AC3	Model Number	Handle Code (see pg. J39)	Price	Front Plate / Contact Diagram
----------------------	----------	--------------	---------------------------	-------	-------------------------------

Step switches with 0-Position - 7 steps

<b>1 Pole</b>	16	V105/64 -	XX	\$80.00
	20	V151/64 -	XX	\$124.00
	25	V251/64 -	XX	\$174.00
	40	V451/64 -	XX	\$257.00
	80	V656/64 -	XX	\$418.00
	100	V756/64 -	XX	\$517.00

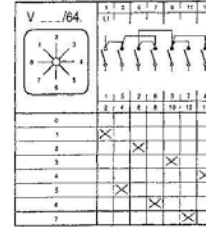

<b>2 Pole</b>	16	V105/1197 -	XX	\$135.00
	20	V151/1197 -	XX	\$211.00
	25	V251/1197 -	XX	\$285.00
	40	V451/1197 -	XX	\$415.00
	80	V656/1197 -	XX	\$705.00
	100	V756/1197 -	XX	\$905.00

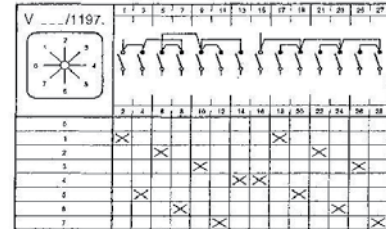

**J20**

Step switches with 0-Position - 8 steps

<b>1 Pole</b>	16	V105/122 -	XX	\$83.00
	20	V151/122 -	XX	\$132.00
	25	V251/122 -	XX	\$184.00
	40	V451/122 -	XX	\$272.00
	80	V656/122 -	XX	\$448.00
	100	V756/122 -	XX	\$563.00

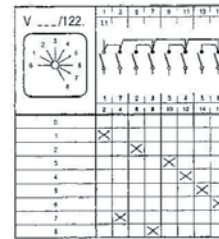

Step switches with 0-Position - 9 steps

<b>1 Pole</b>	16	V105/96 -	XX	\$102.00
	20	V151/96 -	XX	\$150.00
	25	V251/96 -	XX	\$207.00
	40	V451/96 -	XX	\$305.00
	80	V656/96 -	XX	\$504.00
	100	V756/96 -	XX	\$633.00



XX - Replace with Handle Suffix from page J39.

**Discount Schedule SC-10**

**TYPE: STEP SWITCHES WITH 0-POSITION 10/11 STEPS**

**STEP SWITCHES WITH 0-POSITION 10/11 STEPS**

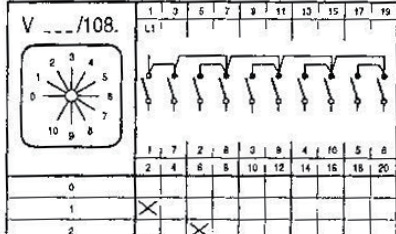
Contact Arrangements	AMPS AC3	Model Number	Handle Code (see pg. J39)	Price	Front Plate / Contact Diagram
Step switches with 0-Position - 10 steps					
<b>1 Pole</b>	16	V105/108 -	XX	\$107.00	
	20	V151/108 -	XX	\$159.00	
	25	V251/108 -	XX	\$218.00	
	40	V451/108 -	XX	\$320.00	
	80	V656/108 -	XX	\$534.00	
	100	V756/108 -	XX	\$677.00	

Step switches with 0-Position - 11 steps

<b>2 Pole</b>	16	V105/113 -	XX	\$118.00
	20	V151/113 -	XX	\$176.00
	25	V251/113 -	XX	\$240.00
	40	V451/113 -	XX	\$352.00
	80	V656/113 -	XX	\$590.00
	100	V756/113 -	XX	\$747.00

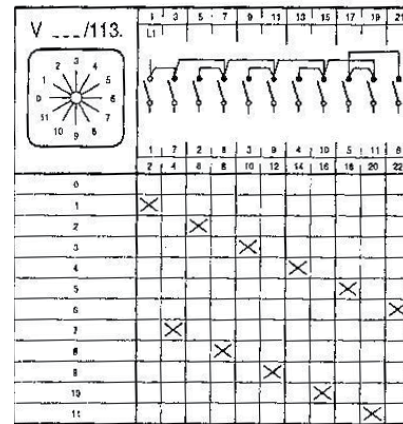

**J21**

XX - Replace with Handle Suffix from page J39.

**Discount Schedule SC-10**

**TYPE: STEP SWITCHES WITH NO 0-POSITION 4 STEPS**

**STEP SWITCHES WITH NO 0-POSITION 4 STEPS**

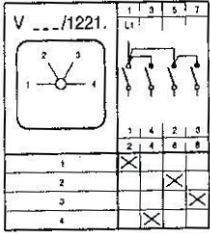
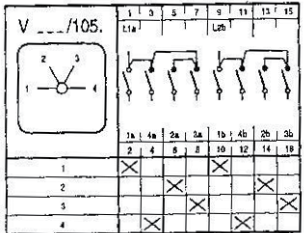
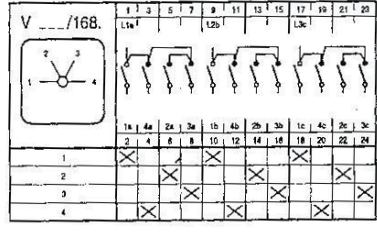
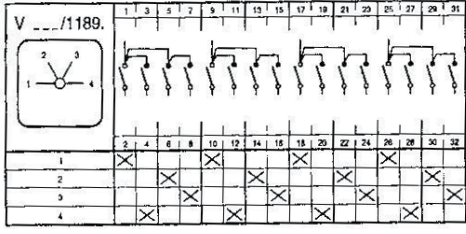
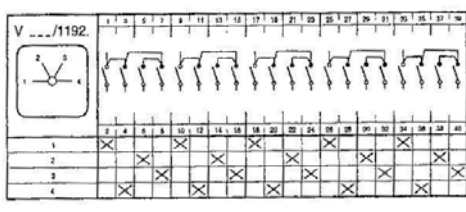
Contact Arrangements	AMPS AC3	Model Number	Handle Code (see pg. J39)	Price	Front Plate / Contact Diagram
<b>1 Pole</b>	16	V105/1221 -	XX	\$53.00	
	20	V151/1221 -	XX	\$80.00	
	25	V251/1221 -	XX	\$117.00	
	40	V451/1221 -	XX	\$172.00	
	80	V656/1221 -	XX	\$266.00	
	100	V756/1221 -	XX	\$332.00	
<b>2 Pole</b>	16	V105/105 -	XX	\$83.00	
	20	V151/105 -	XX	\$132.00	
	25	V251/105 -	XX	\$184.00	
	40	V451/105 -	XX	\$272.00	
	80	V656/105 -	XX	\$448.00	
	100	V756/105 -	XX	\$563.00	
<b>3 Pole</b>	16	V105/168 -	XX	\$125.00	
	20	V151/168 -	XX	\$186.00	
	25	V251/168 -	XX	\$251.00	
	40	V451/168 -	XX	\$368.00	
	80	V656/168 -	XX	\$620.00	
	100	V756/168 -	XX	\$791.00	
<b>4 Pole</b>	16	V105/1189 -	XX	\$144.00	
	20	V151/1189 -	XX	\$237.00	
	25	V251/1189 -	XX	\$318.00	
	40	V451/1189 -	XX	\$465.00	
	80	V656/1189 -	XX	\$791.00	
	100	V756/1189 -	XX	\$1021.00	
<b>5 Pole</b>	16	V105/1192 -	XX	\$165.00	
	20	V151/1192 -	XX	\$290.00	
	25	V251/1192 -	XX	\$386.00	
	40	V451/1192 -	XX	\$563.00	
	80	V656/1192 -	XX	\$964.00	
	100	V756/1192 -	XX	\$1255.00	

XX - Replace with Handle Suffix from page J39.

Discount Schedule SC-10



**TYPE: STEP SWITCHES WITH NO 0-POSITION 4 STEPS**

**STEP SWITCHES WITH NO 0-POSITION 4 STEPS**

Contact Arrangements	AMPS AC3	Model Number	Handle Code (see pg. J39)	Price	Front Plate / Contact Diagram
<b>6 Pole</b>	16	V105/1194 -	XX	\$205.00	
	20	V151/1194 -	XX	\$342.00	
	25	V251/1194 -	XX	\$452.00	
	40	V451/1194 -	XX	\$658.00	
	80	V656/1194 -	XX	\$1136.00	
	100	V756/1194 -	XX	\$1482.00	

<b>1 Pole Separate Contacts</b>	16	V105/1179 -	XX	\$53.00
	20	V151/1179 -	XX	\$81.00
	25	V251/1179 -	XX	\$117.00
	40	V451/1179 -	XX	\$172.00
	80	V656/1179 -	XX	\$266.00
	100	V756/1179 -	XX	\$332.00

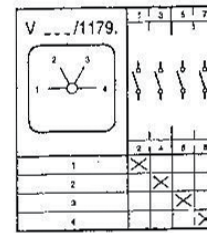

<b>2 Pole Separate Contacts</b>	16	V105/1181 -	XX	\$83.00
	20	V151/1181 -	XX	\$132.00
	25	V251/1181 -	XX	\$185.00
	40	V451/1181 -	XX	\$271.00
	80	V656/1181 -	XX	\$448.00
	100	V756/1181 -	XX	\$563.00

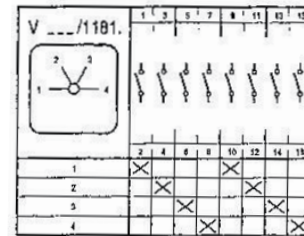

XX - Replace with Handle Suffix from page J39.

**Discount Schedule SC-10**

**J23**

**TYPE: STEP SWITCHES WITH NO 0-POSITION 5 STEPS**

**STEP SWITCHES WITH NO 0-POSITION 5 STEPS**

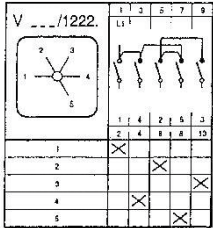
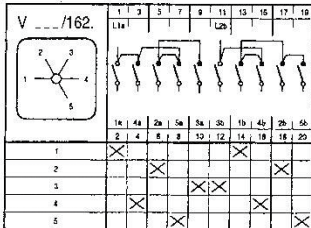
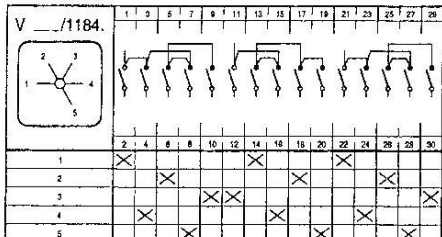
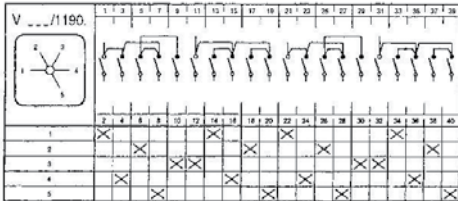
Contact Arrangements	AMPS AC3	Model Number	Handle Code (see pg. J39)	Price	Front Plate / Contact Diagram
<b>1 Pole</b>	16	V105/1222 -	XX	\$70.00	
	20	V151/1222 -	XX	\$98.00	
	25	V251/1222 -	XX	\$142.00	
	40	V451/1222 -	XX	\$209.00	
	80	V656/1222 -	XX	\$329.00	
	100	V756/1222 -	XX	\$403.00	
<b>2 Pole</b>	16	V105/162 -	XX	\$107.00	
	20	V151/162 -	XX	\$159.00	
	25	V251/162 -	XX	\$218.00	
	40	V451/162 -	XX	\$320.00	
	80	V656/162 -	XX	\$532.00	
	100	V756/162 -	XX	\$677.00	
<b>3 Pole</b>	16	V105/1184 -	XX	\$140.00	
	20	V151/1184 -	XX	\$229.00	
	25	V251/1184 -	XX	\$308.00	
	40	V451/1184 -	XX	\$449.00	
	80	V656/1184 -	XX	\$761.00	
	100	V756/1184 -	XX	\$978.00	
<b>4 Pole</b>	16	V105/1190 -	XX	\$165.00	
	20	V151/1190 -	XX	\$290.00	
	25	V251/1190 -	XX	\$386.00	
	40	V451/1190 -	XX	\$563.00	
	80	V656/1190 -	XX	\$964.00	
	100	V756/1190 -	XX	\$1255.00	

XX - Replace with Handle Suffix from page J39.

Discount Schedule SC-10

J24



**TYPE: STEP SWITCHES WITH NO 0-POSITION 6 STEPS**

**STEP SWITCHES WITH NO 0-POSITION 6 STEPS**

Contact Arrangements	AMPS AC3	Model Number	Handle Code (see pg. J39)	Price	Front Plate / Contact Diagram
----------------------	----------	--------------	------------------------------	-------	-------------------------------

<b>1 Pole</b>	16	V105/1223 -	XX	\$74.00
	20	V151/1223 -	XX	\$106.00
	25	V251/1223 -	XX	\$151.00
	40	V451/1223 -	XX	\$224.00
	80	V656/1223 -	XX	\$361.00
	100	V756/1223 -	XX	\$448.00

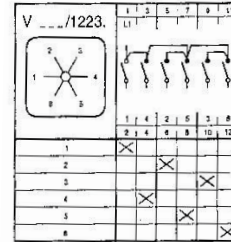

<b>2 Pole</b>	16	V105/163 -	XX	\$125.00
	20	V151/163 -	XX	\$186.00
	25	V251/163 -	XX	\$251.00
	40	V451/163 -	XX	\$368.00
	80	V656/163 -	XX	\$620.00
	100	V756/163 -	XX	\$791.00

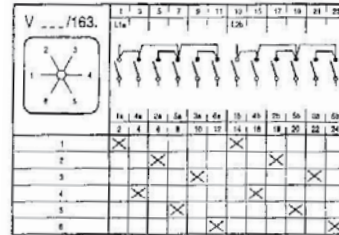

<b>3 Pole</b>	16	V105/1185 -	XX	\$155.00
	20	V151/1185 -	XX	\$264.00
	25	V251/1185 -	XX	\$352.00
	40	V451/1185 -	XX	\$513.00
	80	V656/1185 -	XX	\$877.00
	100	V756/1185 -	XX	\$1138.00

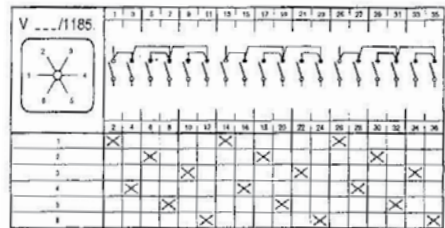

**J25**

XX - Replace with Handle Suffix from page J39.

**Discount Schedule SC-10**

**TYPE: STEP SWITCHES WITH NO 0-POSITION 7 STEPS**

**STEP SWITCHES WITH NO 0-POSITION 7 STEPS**

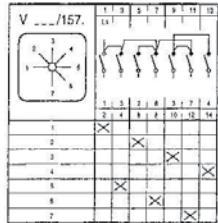
Contact Arrangements	AMPS AC3	Model Number	Handle Code (see pg. J39)	Price	Front Plate / Contact Diagram
<b>1 Pole</b>	16	V105/157-	XX	\$80.00	
	20	V151/157 -	XX	\$124.00	
	25	V251/157 -	XX	\$174.00	
	40	V451/157 -	XX	\$257.00	
	80	V656/157 -	XX	\$418.00	
	100	V756/157 -	XX	\$517.00	

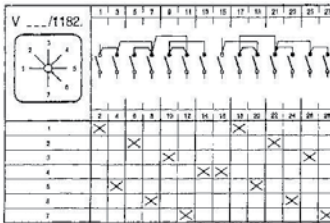
<b>2 Pole</b>	16	V105/1182 -	XX	\$135.00	
	20	V151/1182 -	XX	\$211.00	
	25	V251/1182 -	XX	\$285.00	
	40	V451/1182 -	XX	\$415.00	
	80	V656/1182 -	XX	\$705.00	
	100	V756/1182 -	XX	\$908.00	

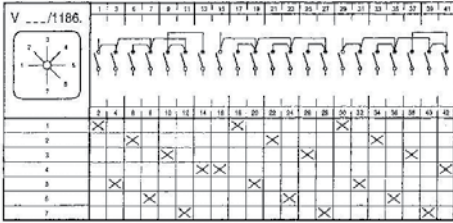
<b>3 Pole</b>	16	V105/1186 -	XX	\$171.00	
	20	V151/1186 -	XX	\$299.00	
	25	V251/1186 -	XX	\$419.00	
	40	V451/1186 -	XX	\$578.00	
	80	V656/1186-	XX	\$994.00	
	100	V756/1186 -	XX	\$1298.00	

**J26**

XX - Replace with Handle Suffix from page J39.

**Discount Schedule SC-10**

**TYPE: STEP SWITCHES WITH NO 0-POSITION 8 STEPS**

**STEP SWITCHES WITH NO 0-POSITION 8 STEPS**

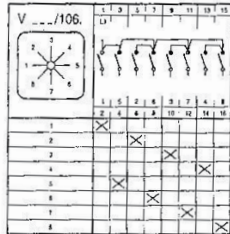
Contact Arrangements	AMPS AC3	Model Number	Handle Code (see pg. J39)	Price	Front Plate / Contact Diagram
<b>1 Pole</b>	16	V105/106-	XX	\$83.00	
	20	V151/106 -	XX	\$132.00	
	25	V251/106 -	XX	\$184.00	
	40	V451/106 -	XX	\$272.00	
	80	V656/106 -	XX	\$448.00	
	100	V756/106 -	XX	\$563.00	

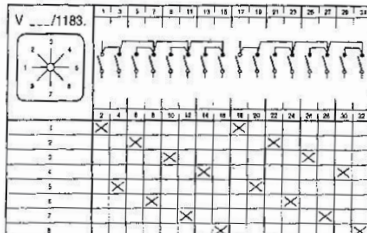
<b>2 Pole</b>	16	V105/1183 -	XX	\$144.00	
	20	V151/1183 -	XX	\$237.00	
	25	V251/1183 -	XX	\$318.00	
	40	V451/1183 -	XX	\$464.00	
	80	V656/1183 -	XX	\$791.00	
	100	V756/1183 -	XX	\$1021.00	

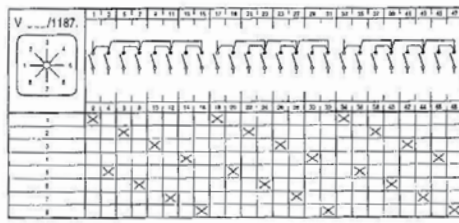
<b>3 Pole</b>	16	V105/1187 -	XX	\$205.00	
	20	V151/1187 -	XX	\$342.00	
	25	V251/1187 -	XX	\$452.00	
	40	V451/1187 -	XX	\$658.00	
	80	V656/1187-	XX	\$1136.00	
	100	V756/1187 -	XX	\$1482.00	

**J27**

XX - Replace with Handle Suffix from page J39.

**Discount Schedule SC-10**

**TYPE: STEP SWITCHES WITH NO 0-POSITION 9/10/11 /12 STEPS**

**STEP SWITCHES WITH NO 0-POSITION 9/10/11/12 STEPS**

Contact Arrangements	AMPS AC3	Model Number	Handle Code (see pg. J39)	Price	Front Plate / Contact Diagram
----------------------	----------	--------------	---------------------------	-------	-------------------------------

Step Switches without 0-Position - 9 Steps

<b>1 Pole</b>	16	V105/158 -	XX	\$102.00
	20	V151/158 -	XX	\$150.00
	25	V251/158 -	XX	\$207.00
	40	V451/158 -	XX	\$305.00
	80	V656/158 -	XX	\$502.00
	100	V756/158 -	XX	\$633.00

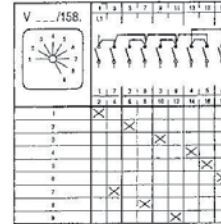

Step Switches without 0-Position - 10 Steps

<b>1 Pole</b>	16	V105/153 -	XX	\$107.00
	20	V151/153 -	XX	\$159.00
	25	V251/153 -	XX	\$218.00
	40	V451/153 -	XX	\$320.00
	80	V656/153 -	XX	\$534.00
	100	V756/153 -	XX	\$677.00

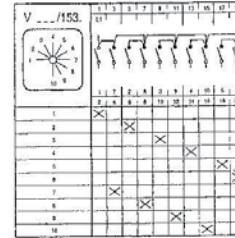

Step Switches without 0-Position - 11 Steps

<b>1 Pole</b>	16	V105/159 -	XX	\$118.00
	20	V151/159 -	XX	\$176.00
	25	V251/159 -	XX	\$240.00
	40	V451/159 -	XX	\$352.00
	80	V656/159 -	XX	\$590.00
	100	V756/159 -	XX	\$747.00

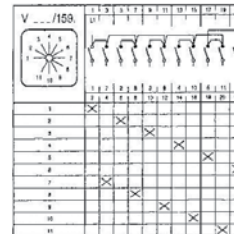

Step Switches without 0-Position - 12 Steps

<b>1 Pole</b>	16	V105/160 -	XX	\$125.00
	20	V151/160 -	XX	\$186.00
	25	V251/160 -	XX	\$251.00
	40	V451/160 -	XX	\$368.00
	80	V656/160 -	XX	\$620.00
	100	V756/160 -	XX	\$791.00

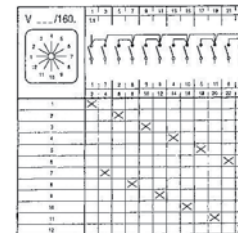

XX - Replace with Handle Suffix from page J39.

**Discount Schedule SC-10**

**TYPE: GROUP SWITCHES, 2 GROUPS IN SERIES**

**GROUP SWITCHES, 2 GROUPS IN SERIES**

Contact Arrangements	AMPS AC3	Model Number	Handle Code (see pg. J39)	Price	Front Plate / Contact Diagram
<b>1 Pole</b>	16	V105/1206-	XX	\$43.00	
	20	V151/1206 -	XX	\$59.00	
	25	V251/1206 -	XX	\$80.00	
	40	V451/1206 -	XX	\$110.00	
	80	V656/1206 -	XX	\$161.00	
	100	V756/1206 -	XX	\$220.00	

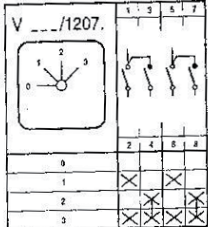
<b>2 Pole</b>	16	V105/1207 -	XX	\$53.00	
	20	V151/1207 -	XX	\$81.00	
	25	V251/1207-	XX	\$117.00	
	40	V451/1207 -	XX	\$172.00	
	80	V656/1207 -	XX	\$266.00	
	100	V756/1207 -	XX	\$334.00	

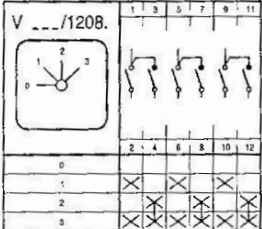
<b>3 Pole</b>	16	V105/1208 -	XX	\$74.00	
	20	V151/1208 -	XX	\$107.00	
	25	V251/1208 -	XX	\$152.00	
	40	V451/1208 -	XX	\$223.00	
	80	V656/1208-	XX	\$363.00	
	100	V756/1208 -	XX	\$448.00	

**J29**

XX - Replace with Handle Suffix from page J39.

**Discount Schedule SC-10**

**TYPE: GROUP SWITCHES, 2 GROUPS**

**GROUP SWITCHES, 2 GROUPS**

Contact Arrangements	AMPS AC3	Model Number	Handle Code (see pg. J39)	Price	Front Plate / Contact Diagram
----------------------	----------	--------------	---------------------------	-------	-------------------------------

<b>1 Pole</b>	16	V105/46-	XX	\$43.00
	20	V151/46 -	XX	\$55.00
	25	V251/46 -	XX	\$79.00
	40	V451/46 -	XX	\$110.00
	80	V656/46 -	XX	\$161.00
	100	V756/46 -	XX	\$220.00

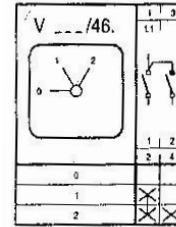

<b>2 Pole</b>	16	V105/1204 -	XX	\$53.00
	20	V151/1204 -	XX	\$81.00
	25	V251/1204-	XX	\$117.00
	40	V451/1204 -	XX	\$172.00
	80	V656/1204 -	XX	\$266.00
	100	V756/1204 -	XX	\$334.00

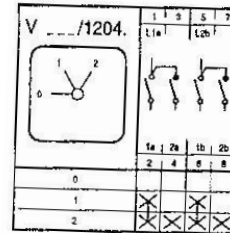

<b>3 Pole</b>	16	V105/174-	XX	\$74.00
	20	V151/174 -	XX	\$106.00
	25	V251/174 -	XX	\$151.00
	40	V451/174 -	XX	\$224.00
	80	V656/174-	XX	\$363.00
	100	V756/174 -	XX	\$448.00

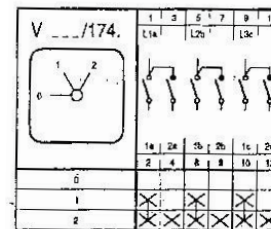

XX - Replace with Handle Suffix from page J39.

**Discount Schedule SC-10**

**TYPE: GROUP SWITCHES, 3 GROUPS**

**GROUP SWITCHES, 3 GROUPS**

Contact Arrangements	AMPS AC3	Model Number	Handle Code (see pg. J39)	Price	Front Plate / Contact Diagram
<b>1 Pole</b>	16	V105/38-	XX	\$48.00	
	20	V151/38 -	XX	\$72.00	
	25	V251/38 -	XX	\$104.00	
	40	V451/38 -	XX	\$149.00	
	80	V656/38 -	XX	\$224.00	
	100	V756/38 -	XX	\$277.00	

<b>2 Pole</b>	16	V105/1205 -	XX	\$74.00
	20	V151/1205 -	XX	\$107.00
	25	V251/1205-	XX	\$152.00
	40	V451/1205 -	XX	\$223.00
	80	V656/1205 -	XX	\$363.00
	100	V756/1205 -	XX	\$448.00

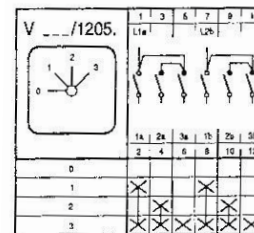

<b>3 Pole</b>	16	V105/30-	XX	\$102.00
	20	V151/30 -	XX	\$205.00
	25	V251/30 -	XX	\$305.00
	40	V451/30 -	XX	\$353.00
	80	V656/30-	XX	\$504.00
	100	V756/30 -	XX	\$633.00

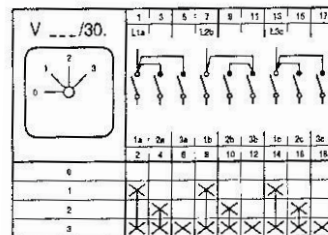

**J31**

XX - Replace with Handle Suffix from page J39.

**Discount Schedule SC-10**



TYPE: CODE SWITCHES, BINARY CODE

CODE SWITCHES, BINARY CODE

Contact Arrangements	AMPS AC3	Model Number	Handle Code (see pg. J39)	Price
<b>0-7</b>	16	V105/1403-	XX	\$48.00
	20	V151/1403 -	XX	\$72.00
	25	V251/1403 -	XX	\$104.00
<b>0-7 Compliment</b>	16	V105/1404-	XX	\$48.00
	20	V151/1404 -	XX	\$72.00
	25	V251/1404 -	XX	\$104.00
<b>0-7 + Compliment</b>	16	V105/1405-	XX	\$74.00
	20	V151/1405 -	XX	\$107.00
	25	V251/1405 -	XX	\$152.00
<b>0-11</b>	16	V105/1406-	XX	\$53.00
	20	V151/1406 -	XX	\$81.00
	25	V251/1406 -	XX	\$117.00
<b>0-11 Compliment</b>	16	V105/1407-	XX	\$53.00
	20	V151/1407 -	XX	\$81.00
	25	V251/1407 -	XX	\$117.00
<b>0-11 + Compliment</b>	16	V105/1408-	XX	\$84.00
	20	V151/1408 -	XX	\$132.00
	25	V251/1408 -	XX	\$185.00

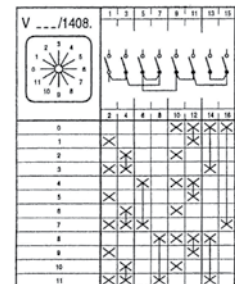
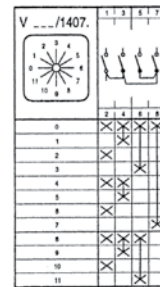
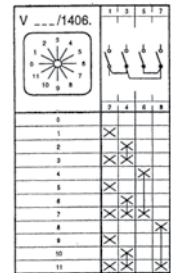
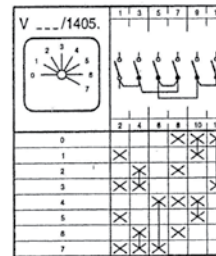
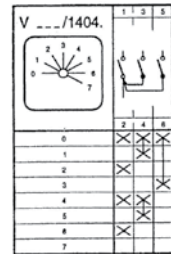
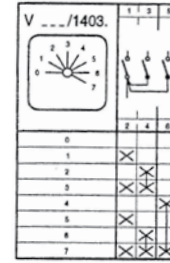

XX - Replace with Handle Suffix from page J39.

Discount Schedule SC-10

J 32



**TYPE: CODE SWITCHES, BCD CODE**

**CODE SWITCHES, BCD CODE**

Contact Arrangements	AMPS AC3	Model Number	Handle Code (see pg. J39)	Price	Front Plate / Contact Diagram
----------------------	----------	--------------	---------------------------	-------	-------------------------------

<b>0-9</b>	16	V105/1409-	XX	\$53.00
	20	V151/1409 -	XX	\$81.00
	25	V251/1409 -	XX	\$117.00

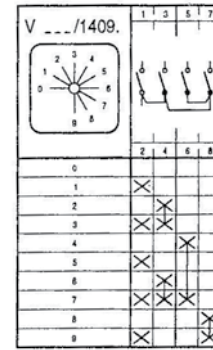

<b>0-9 Compliment</b>	16	V105/1410-	XX	\$53.00
	20	V151/1410 -	XX	\$81.00
	25	V251/1410 -	XX	\$117.00

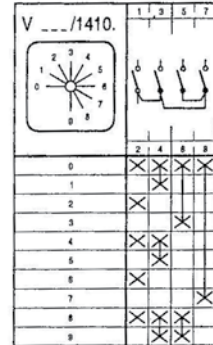

<b>0-9 + Compliment</b>	16	V105/1411-	XX	\$84.00
	20	V151/1411 -	XX	\$132.00
	25	V251/1411 -	XX	\$185.00

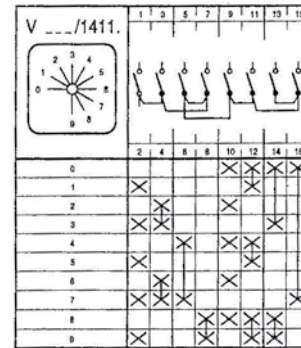

XX - Replace with Handle Suffix from page J39.

**Discount Schedule SC-10**

**J33**

**TYPE: VOLTMETER SELECTOR**

**VOLTMETER SELECTOR**

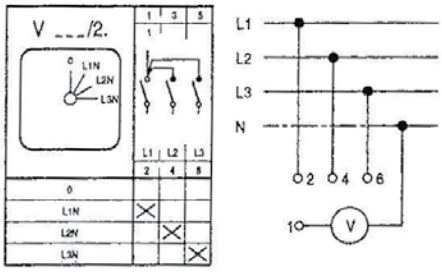
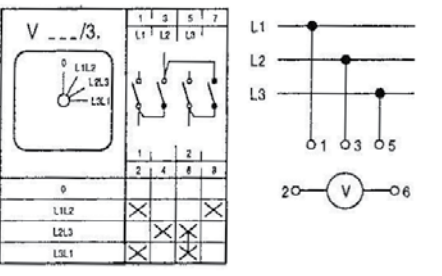
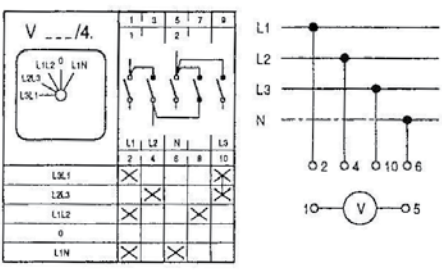
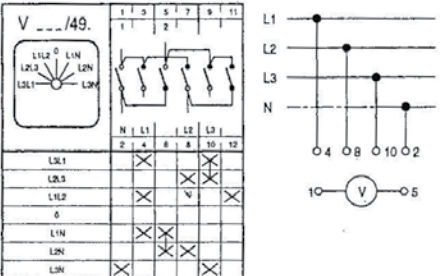
Contact Arrangements	AMPS AC3	Model Number	Handle Code (see pg. J39)	Price	Front Plate / Contact Diagram
<b>3 Phases to N</b>	16	V105/2-	XX	\$48.00	
<b>3 Line Voltages</b>	16	V105/3-	XX	\$53.00	
<b>3 Line Voltages 1 Phase to N</b>	16	V105/4-	XX	\$70.00	
<b>3 Line Voltages 3 Phases to N</b>	16	V105/49-	XX	\$74.00	

J 34

XX - Replace with Handle Suffix from page J39.

Discount Schedule SC-10

**TYPE: VOLTMETER SELECTOR**

**VOLTMETER SELECTOR**

Contact Arrangements	AMPS AC3	Model Number	Handle Code (see pg. J39)	Price	Front Plate / Contact Diagram
<b>3 Line Voltages for 2 Mains</b>	16	V105/188-	XX	\$83.00	

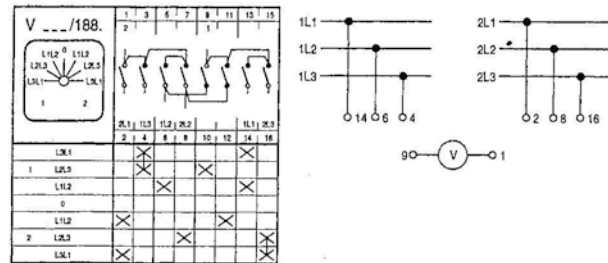

<b>3 Line Voltages</b>	16	V105/1144-	XX	\$53.00	
------------------------	----	------------	----	---------	--

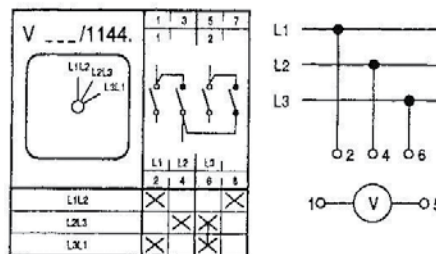

<b>3 Line Voltages 3 Phase to N</b>	16	V105/1210-	XX	\$74.00	
-------------------------------------	----	------------	----	---------	--

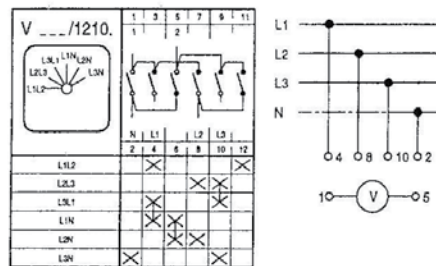

XX - Replace with Handle Suffix from page J39.

**Discount Schedule SC-10**

**TYPE: AMMETER SELECTOR**

**AMMETER SELECTOR**

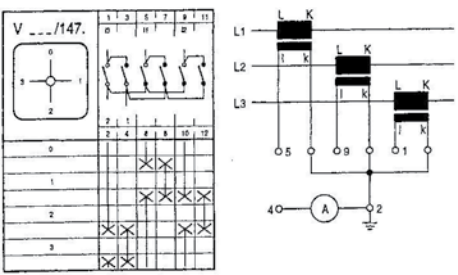
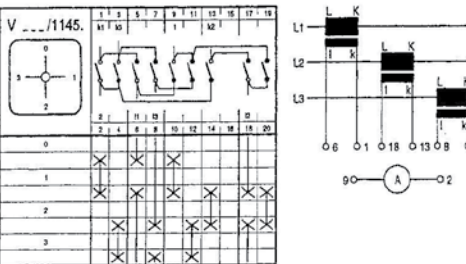
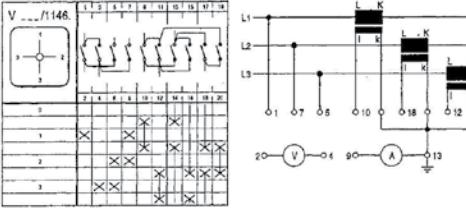
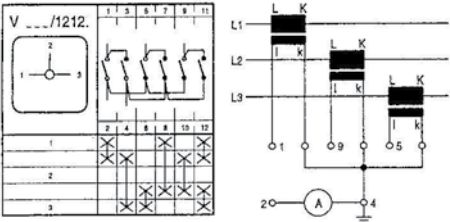
Contact Arrangements	AMPS AC3	Model Number	Handle Code (see pg. J39)	Price	Front Plate / Contact Diagram
<b>1 Pole 3 Transformer Circuits</b>	16	V105/147-	XX	\$74.00	
<b>2 Pole 3 Transformer Circuits</b>	16	V105/1145-	XX	\$107.00	
<b>3 Voltages 3 Currents</b>	16	V105/1146-	XX	\$107.00	
<b>1 Pole 3 Transformer Circuits</b>	16	V105/1212-	XX	\$74.00	

J 36

XX - Replace with Handle Suffix from page J39.

**Discount Schedule SC-10**

**TYPE: AMMETER SELECTOR**

**AMMETER SELECTOR**

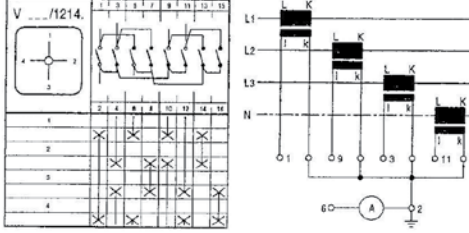
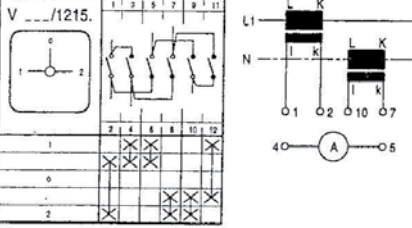
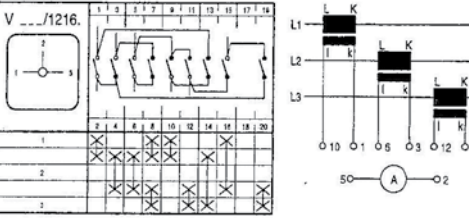
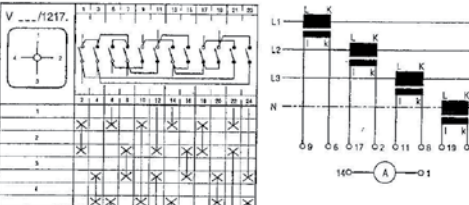
Contact Arrangements	AMPS AC3	Model Number	Handle Code (see pg. J39)	Price	Front Plate / Contact Diagram
<b>1 Pole 4 Transformer Circuits</b>	16	V105/1214-	XX	\$83.00	
<b>2 Pole 2 Transformer Circuits</b>	16	V105/1215-	XX	\$74.00	
<b>2 Pole 3 Transformer Circuit</b>	16	V105/1216-	XX	\$107.00	
<b>2 Pole</b>	16	V105/1217-	XX	\$125.00	

**J37**

XX - Replace with Handle Suffix from page J39.

**Discount Schedule SC-10**

TYPE: SINGLE-PHASE STARTER SWITCHES

SINGLE-PHASE STARTER SWITCHES

Contact Arrangements	AMPS AC3	Model Number	Handle Code (see pg. J39)	Price	Front Plate / Contact Diagram
<b>With Starter Capacitor</b>	16	E105/1-	XX	\$48.00	<p>with starting capacitor</p>
	20	E151/1-	XX	\$72.00	
	25	E251/1-	XX	\$104.00	
<b>With Starter Capacitor</b>	20	E151/2-	XX	\$107.00	<p>with starting capacitor</p>
	25	E251/2-	XX	\$104.00	
<b>2 Reversing</b>	16	E105/3-	XX	\$74.00	<p>with starting capacitor</p>
	20	E151/3-	XX	\$106.00	
	25	E251/3-	XX	\$152.00	
<b>2 Reversing</b>	20	E151/4-	XX	\$106.00	<p>with starting capacitor</p>
	25	E251/4-	XX	\$152.00	
<b>With Running Capacitor</b>	16	E105/5-	XX	\$74.00	<p>with starting capacitor</p>
	20	E151/5-	XX	\$106.00	
	25	E251/5-	XX	\$152.00	

J 38

XX - Replace with Handle Suffix from page J39.

Discount Schedule SC-10

**HANDLE & MOUNTING CODE - CAM SWITCHES**

- 3 mounting styles available for cam switches (see below).  
Replace “XX” suffix from cam part number with letter suffix below. (Example: A251/6-AB, Front Mount 4-hole)
- Standard black lever handle used on all cam switches (custom handles are available on request.)
- Price of switch includes handle and mounting style.
- Cam switches available with enclosure; polycarbonate or aluminum. Consult factory.

**Front Mount; 4-hole\***



Model / Series	Suffix*
105, 151	AA
251, 451	AB
656, 756	AC

**Base Mount; Screw Fixing\***



Model / Series	Suffix*
105, 151	PB
251, 451	PC
656, 756	PD

**Central Mount; 1-Hole (22.5mm or 30.5mm)\***



Model / Series	Suffix*
105, 151, 251	CA
451, 656, 756	Not Available

\* All cam handles Black/Grey in color. Consult factory for Red/Yellow. See page J40 for dimensions.



**HANDLE & MOUNTING DIMENSIONS**

**Front Mount; 4-Hole Dimensions**

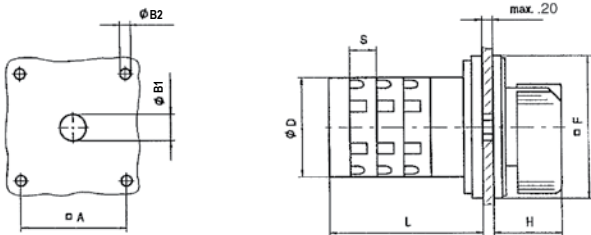

Type	Dimension (Inches)							L By Switch Contacts			
	A	B1	B2	D	F	H	S	1-2	3-4	5-6	7-8
105	1.42	.47	.18	1.73	1.89	1.14	.49	1.34	1.83	2.32	2.81
151	1.42	.47	.18	1.93	1.89	1.14	.49	1.79	2.28	2.78	3.27
251	1.89	.47	.22	2.48	2.52	1.30	.49	1.93	2.42	2.91	3.41
451	1.89	.47	.22	2.83	2.52	1.30	.69	2.13	2.81	3.50	4.19
656	2.68	.59	.22	3.15	3.46	1.38	.63	2.13	2.76	3.39	4.02
756	2.68	.59	.22	3.39	3.46	1.38	1.04	2.52	3.56	4.61	5.65

**Base Mount; Screw Fixing Dimensions**

J40

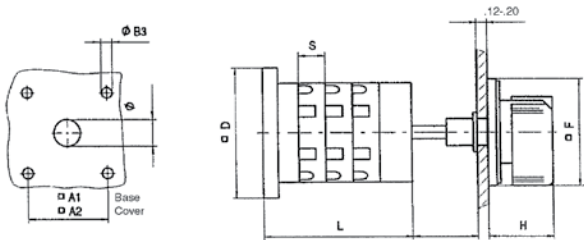

Type	Dimension (Inches)							L By Switch Contacts			
	A1	A2	B3	D	F	H	S	1-2	3-4	5-6	7-8
105	1.42	1.42	.18	1.73	1.89	1.14	.49	1.34	1.83	2.32	2.81
151	1.89	1.42	.18	2.40	1.89	1.14	.49	1.71	2.20	2.70	3.19
251	1.89	1.89	.20	2.40	2.52	1.30	.49	1.85	2.34	2.83	3.33
451	2.68	1.89	.20	3.62	2.52	1.30	.69	2.05	2.74	3.43	4.11
656	2.68	2.68	.22	3.62	3.46	1.38	.63	2.05	2.68	3.31	3.94
756	2.68	2.68	.22	3.62	3.46	1.38	1.04	2.44	3.48	4.53	5.57

**Central Mount; 1 Hole Dimensions (22.5mm or 30.5mm)**

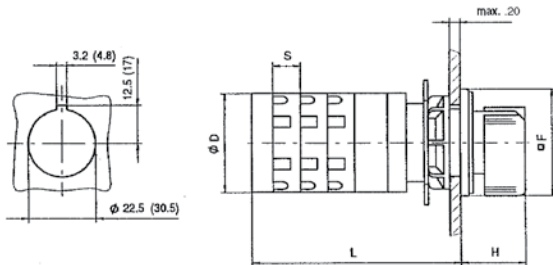

Type	Dimension (Inches)				L By Switch Contacts			
	D	F	H	S	1-2	3-4	5-6	7-8
105	1.73	1.89	1.14	.49	1.89	2.38	2.87	3.37
151	1.93	1.89	1.14	.49	2.70	3.19	3.68	4.17
251	2.48	2.52	1.30	.49	2.83	3.33	3.82	4.31



**CAM SWITCH ENCLOSURES**

All cam switches can be designated to an enclosure. Enclosures are available in polycarbonate or aluminum cast-iron. Consult factory for pricing of a complete enclosed switch.

**Dimensional Data**

Dimensions are enclosure only; does not include the handle dimension.

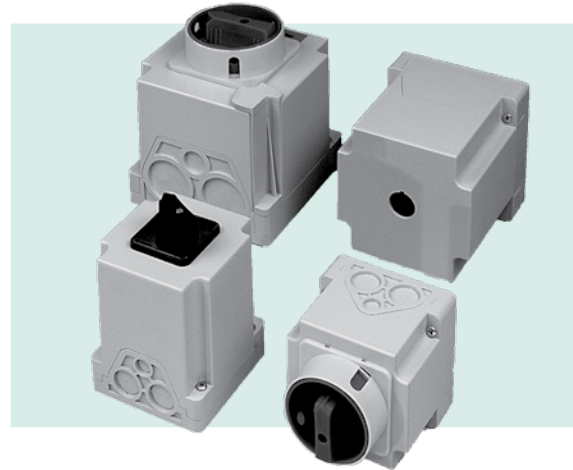

**Polycarbonate (IP65 rated)**

Series	L x W x D (mm)	Mounting Hole to Hole	Enclosure Type
105	90.5 x 90.5 x 73	80 mm	I1 - D - NL4
105	90.5 x 90.5 x 110	80 mm	I1 - D - HL4
151, 251, ML1	115 x 115 x 98	100 mm	I2 - D - NL4
151, 251, ML1	115 x 115 x 125	100 mm	I2 - D - HL4
451, ML2	145 x 145 x 120	130 mm	I3 - D - NL4
451, ML2	145 x 145 x 150	130 mm	I3 - D - HL4
656*, 756*	300 x 300 x 170	271 mm	I7N
656*, 756*	300 x 300 x 214	271 mm	I7H

\* Clear polycarbonate cover face

**Aluminum Cast-Iron (IP54 rated)**

Series	L x W x D (mm)	Mounting Hole to Hole	Enclosure Type
105, 151	105 x 105 x 79	80 mm	A18
151, 251	121 x 121 x 92	80 mm	A19

\* Consult factory for additional sizes

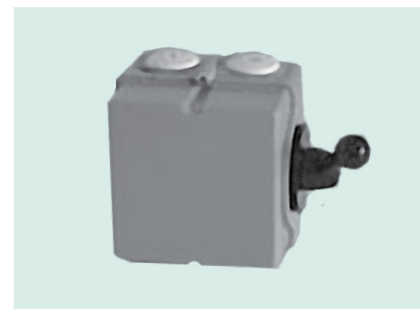

CAM SWITCH ACCESSORIES

Extension Terminal

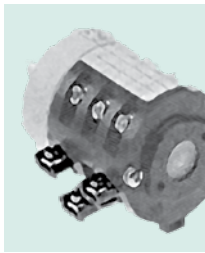

Type	Catalog No.	Price
Extension Terminals	AS	*C.F.

\* C.F. - Consult Factory items will vary in price according to switch configuration.

Blade Terminal

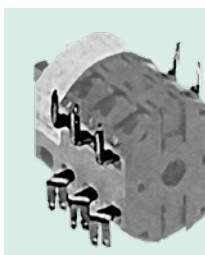

Type	Catalog No.	Price
Blade Terminals	F	*C.F.

\* C.F. - Consult Factory items will vary in price according to switch configuration.

Auxiliaries



Type	Catalog No.	Price
PE Terminals	PE	\$11
N Terminals	N	\$11

Protection Covers



Type	Catalog No.	Price
Protection Covers	DH	*C.F.

\* C.F. - Consult Factory items will vary in price according to switch configuration.

Voltage Release - Loss of Voltage

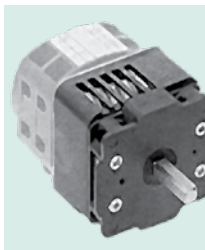

Type	Catalog No.	Price
Voltage Release	U	*C.F.

24V AC, 120V AC, 240V AC

\* C.F. - Consult Factory items will vary in price according to switch configuration.

Front Plates For Central 2 & 3 Hole Mounting

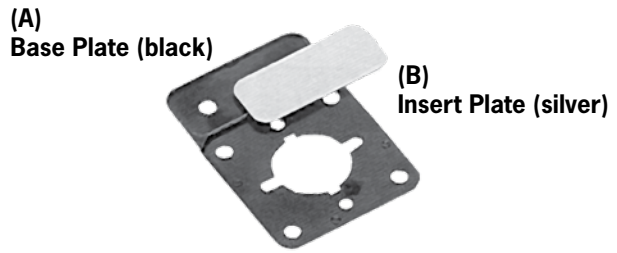

Type	Color	Size	Dimension	Catalog No.	Price
A	Black	0	30 x 51mm	EB91	\$3.00
A	Black	1	48 x 69mm	EB64	\$3.00
B	Silver	0		ES	\$3.00
B	Silver	1		ES1	\$3.00

Front Plates Size 1 & Size 2

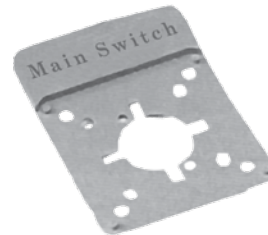

Color	Size	Dimension	Catalog No.	Price
Yellow	1	66 x 89mm	MSY	\$8.00
Grey	2	86 x 108mm	MSG	\$8.00

Base & Rear Mounting Up To Series 451

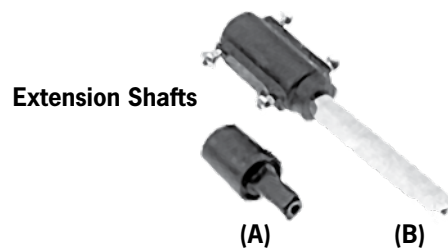

Type	Size	Catalog No.	Price
A	18mm (max. 5 pcs.)	AL18	\$3.00
B	65 - 80mm	AL-65	\$16.00
B	165 - 205mm	AL165	\$19.00
B	265 - 305mm	AL265	\$23.00
B	365 - 405mm	AL365	\$31.00

Discount Schedule SC-10

## SPECIAL ORDER FORM

**Name:** \_\_\_\_\_  
**Company:** \_\_\_\_\_  
**P.O. Box:** \_\_\_\_\_  
**Street Address:** \_\_\_\_\_  
**City, State, Zip** \_\_\_\_\_  
**Telephone #** \_\_\_\_\_  
**Fax #** \_\_\_\_\_  
**e-mail address** \_\_\_\_\_

send to:

**Springer Controls Co., Inc.**

96074 Chester Road  
Yulee, Florida 32097

Phone: (904) 225-0575

Fax: (904) 225-9084

[www.SpringerControls.com](http://www.SpringerControls.com)

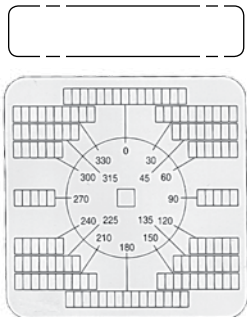
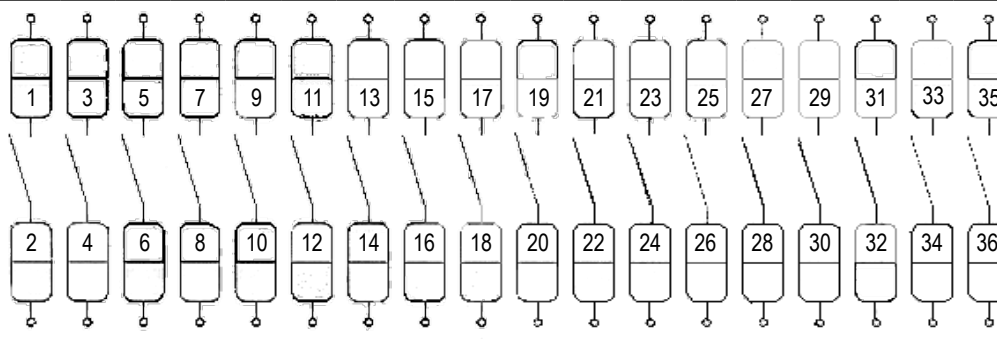
Front Plate 																	
Switching Angle	<input type="radio"/> Complete Rotation																
Switch Position Marking	Degree																
<input type="checkbox"/> Key Removable <input type="checkbox"/> Spring Return		<input type="checkbox"/> Contact Closed				<input type="checkbox"/> Contact Closed Without Interruption				<input type="checkbox"/> Wiping Contact							
Series:	Accessories:																
Application:																	
Quantity:																	
Date:	Writer:	Factory Type:								Factory Order No.:							



NOTES

J44